



APPENDIX K

Geology and Soils Data



K.1

Fault Rupture Study





Prepared for:

Pacifica Services, Inc.
106 South Mentor Avenue, Suite 200
Pasadena, California 91106

**FAULT RUPTURE HAZARD EVALUATION
IN SUPPORT OF DRAFT EIR
INGLEWOOD TRANSIT CONNECTOR
PROJECT
INGLEWOOD, CALIFORNIA**

Prepared by:



engineers | scientists | innovators

16644 West Bernardo Drive, Suite 301
San Diego, California 92127

Project Number: HPA1043-05

27 September 2019

FAULT RUPTURE HAZARD EVALUATION IN SUPPORT OF DRAFT EIR

Inglewood Transit Connector Project Inglewood, California

This report was prepared under the supervision
and direction of the undersigned.

Prepared by:

Geosyntec Consultants, Inc.

16644 West Bernardo Drive, Suite 301
San Diego, CA 92127



Alexander Greene, P.G., C.E.G.
Senior Principal Engineering Geologist



Jared Warner, P.G.
Project Geologist

TABLE OF CONTENTS

1.	INTRODUCTION	1
	1.1 Project Description	1
	1.2 Objective and Scope of Services	2
2.	METHODS	3
3.	ALQUIST-PRIOLO EARTHQUAKE FAULT ZONES AND FAULTS.....	4
4.	RECORDS REVIEW	5
	4.1 City of Inglewood Building and Safety Division	5
	4.2 CGS	5
	4.3 Caltrans	6
	4.4 Los Angeles County Department of Public Works	6
	4.5 Metro	7
	4.5.1 Earth Mechanics, Inc., [EMI, 2010]	7
	4.5.2 Geotechnical Data Report, [HMM, 2012a]	9
	4.5.3 Preliminary Geotechnical Engineering Design Technical Memorandum [HMM, 2012b]	10
	4.5.4 Discussions with Metro Technical Personnel	11
	4.6 USGS	12
5.	SUMMARY OF FINDINGS	13
	5.1 Potential Fault Rupture Hazards Identified	13
	5.2 Initial Design Inputs	13
	5.3 Data Gaps	13
6.	CONCLUSIONS AND RECOMMENDATIONS	15
7.	LIMITATIONS.....	17
8.	REFERENCES	18

TABLE OF CONTENTS (Continued)

LIST OF TABLES

Table 1: Summary of Previous Fault Investigations

LIST OF FIGURES

Figure 1: Site Location

Figure 2: Alquist-Priolo Fault Hazard Zones and Geologic Map

Figure 3: Fault Map

Figure 4: Previous Fault Hazard Investigation Map

Figure 5 and 5a: Townsite Fault

1. INTRODUCTION

This summary report has been prepared by Geosyntec Consultants, Inc. (Geosyntec) for Pacifica Services, Inc. (Pacifica) to present the findings of a desktop-level fault rupture hazard evaluation performed in support of the Draft Environmental Impact Report (EIR) for the proposed Inglewood Transit Connector Project (the ITC; project) in Inglewood, California. This report was prepared by Mr. Jared Warner, P.G., and reviewed by Mr. Alexander Greene, P.G., C.E.G., and Mr. Christopher Conkle, P.E., of Geosyntec, in accordance with the peer review policy of the firm.

1.1 Project Description

The City of Inglewood (City) is in the process of developing an automated people mover system (APM) titled the Inglewood Transit Connector (the ITC) project that would provide a transit connection from downtown Inglewood and the Metro Crenshaw/LAX Line to the City's major activity centers, including the Forum, the Los Angeles Stadium and Entertainment District (LASED), and the proposed Inglewood Basketball and Entertainment Center (IBEC). A Pacifica (prime contractor with the City) team will be preparing an EIR under the requirements of the California Environmental Quality Act (CEQA) to support the project.

Per the ITC Project Initial Study, released in July 2018 [Meridian, 2018], the project will consist of an elevated, automated people mover (APM) system. The length of the proposed APM system is approximately 1.8 miles, extending southward from the Market Street/Metro Crenshaw Line connection along South Market Street, continuing eastward along East Manchester Boulevard, southward along North Prairie Avenue, and terminating at the intersection of West Century Boulevard and Prairie Avenue located adjacent to the LASED and IBEC (Figure 1). In addition to dual aerial guideways, the project will also consist of up to 5 APM stations, a Maintenance and Storage Facility (MSF), and one Intermodal Transportation Facility (ITF). Potential locations of these facilities are shown on Figure 1.

An alternative project design (Market Street Alternative) is being considered which relates to the parcel at the southeastern corner of Market Street and Florence Avenue (Figure 1). It is our understanding that the proposed Market Street Alternative would include an alternate guideway alignment near the northern terminal of the line, a pedestrian walkway connecting to the Metro Florence/La Brea Station, an above-ground mezzanine, vehicle parking, and potentially commercial and residential development. The components of the Market Street Alternative were included in the preliminary design plans provided to Geosyntec, dated 28 November 2018 and titled "Streetscape A- Market

Street Alt 1” and “Streetscape A- Market Street Alt 1 – High” and are shown on Figures 1 and 5).

CEQA Guidelines indicate that a project would have a significant effect from fault rupture impacts if it were to “*expose people or structures to substantial adverse effects, including the risk of loss, injury, or death, involving rupture of a known earthquake fault, as delineated on the most recent Alquist-Priolo Earthquake Fault Zone (APEFZ) map for the area or based on other substantial evidence of a known fault.*” Based on the Geology and Soils Technical Memorandum prepared for ITC Project Initial Study [Geosyntec, 2018], fault rupture was identified as a “potentially significant impact” to the project. To further address this significance criteria, Pacifica has requested that Geosyntec perform this desktop-level evaluation to provide more-detailed information regarding the significance of potential fault rupture for both the base case and Market Street Alternative, along with the development of potential mitigations as appropriate.

1.2 Objective and Scope of Services

The objective of this desktop-level evaluation was to provide additional information regarding the significance of potential fault rupture hazard along the base case and Market Street Alternative project alignments. Professional services in support of this project were performed in accordance with our approved proposal, dated 21 September 2018. The scope of services included the following:

- Researching the availability of fault rupture related documentation from federal, state, and local sources within the vicinity of the project alignment;
- Reviewing available physiographic information including geologic and geotechnical information;
- Performing on-line and in-person data searches of available documents; and
- Documenting the procedures, findings, opinions, and conclusions of the fault rupture hazard evaluation in this report.

2. METHODS

The evaluation of fault rupture hazard was based on a review of maps and readily accessible geologic and geotechnical records obtained from publicly available online resources, including municipalities and agencies with jurisdiction near or along the project alignment. Online and in-person data searches were performed in order to compile available documents and incorporate relevant information into our assessment. No site reconnaissance, geologic mapping, subsurface, or site-specific investigations were performed as part of our evaluation.

3. ALQUIST-PRIOLO EARTHQUAKE FAULT ZONES AND FAULTS

Fault rupture hazard was evaluated to assess the potential for exposure of people or structures to substantial adverse effects, including the risk of loss, injury, or death. The potential for fault surface rupture is generally considered to be significant along “active” faults and to a lesser degree along “potentially active” faults [CDMG, 1998; USGS, 2018].

The ITC alignment does not lie within the boundaries of APEFZ delineated active or potentially active faults (Figure 2) as defined by the State of California in the Alquist-Priolo (A-P) Earthquake Zoning Act [CGS, 1999]. The nearest APEFZs to the Project include two segments of the Newport-Inglewood fault zone located approximately 280-feet west of the alignment along North Market Street (Inglewood fault), and approximately 2,750-feet east of the alignment from the intersection of West Manchester Boulevard and Prairie Avenue (Potrero fault), as presented on Figures 2 and 3. Therefore, a project Site-specific fault hazard evaluation in accordance with the A-P Earthquake Fault Zoning Act (Public Resources Code [PRC] Sections 2621-2630), is not required per State regulation.

4. RECORDS REVIEW

Geosyntec contacted federal, state, and local agencies, and accessed associated online databases to identify geologic and geotechnical information pertaining to the project area. Requests to and documents received from the following agencies are listed below:

- City of Inglewood Building and Safety Division;
- California Geologic Survey (CGS);
- California Department of Transportation (Caltrans);
- Los Angeles County Department of Public Works (DPW) – Building and Safety;
- Los Angeles County Metropolitan Transportation Authority (Metro); and
- United State Geological Survey (USGS)

As part of this records review, Geosyntec reviewed 42 separate investigations within the general project area. Pertinent records received to date and/or reviewed on publicly available online sources are summarized below. If files are received after finalization of this report that change the conclusions stated herein, an addendum will be prepared.

4.1 City of Inglewood Building and Safety Division

On 13 December 2018, Geosyntec performed an in-person document review at the City of Inglewood Building and Safety Division’s permit counter. Geosyntec requested previous fault hazard investigation reports for 61 Assessor’s Parcel Numbers (APNs) adjacent to or within the vicinity of the project. This initial document request primarily focused on parcels with the highest likelihood for having previous fault hazard studies, consisting of larger developments, commercial properties, hospitals, schools, and other critical facilities. Of the reports provided by the City, only three contained information on previous fault hazard studies. Additionally, transmittal of digital or electronic copies of these reports were not permitted by the City. Locations of the previous investigations reviewed are shown in Figure 4. A summary of the reports and their findings are presented in Table 1.

4.2 CGS

On 21 December 2018, Geosyntec received the “A-P Site Investigations Database” (.kmz file) from the CGS. The database includes the A-P File Number and locations of previous fault hazard investigations performed within and/or near mapped A-P Zones in California, through 18 August 2016. Following review of the database, Geosyntec

requested reports for 37 previous fault investigations completed adjacent to or within the vicinity of the Project. Locations of the previous investigations are also shown in Figure 5. A summary of the reports and their findings are presented in Table 1.

Based on the review of previous fault hazard investigation reports received from the CGS, evidence of faulting or previous fault rupture within the immediate vicinity of the project was only identified in one of the 37 investigations reviewed. The findings of that study are described below.

AP File No. 2187 - Preliminary Geologic Exploration Special Studies Zone Review, Jeffery A. Johnson, Inc. (Johnson, 1988)

Johnson performed a fault hazard investigation for a proposed El Pollo Loco restaurant located at 426 North La Brea Avenue, Inglewood, California, which is situated within an established APEFZ. Johnson identified a fault strand associated with the Newport-Inglewood fault zone within three excavated trenches performed at the site. Johnson indicated that although previous removal of the upper sediments at the site precluded age estimation of the most recent movement or rupture, the fault should be considered active. The investigations performed for this study are situated approximately 0.25 miles northwest of the proposed Market Street APM Station (Figure 4) and appears to generally correspond to the mapped location of the Inglewood APEFZ.

4.3 Caltrans

Geosyntec queried Caltrans Digital Archive of Geotechnical Data (GeoDOG) website [State of California, 2017] on 14 December 2018. No previous fault hazard investigations performed within the project area were identified in the Caltrans database.

4.4 Los Angeles County Department of Public Works

On 17 December 2018, Geosyntec contacted the Los Angeles County Department of Public Works (DPW) requesting previous fault hazard investigations for parcels in the vicinity under their jurisdiction. DPW provided reports for investigations previously performed at the southern portion of Los Angeles Southwest College, located approximately 2.3 miles southeast of the planned Century Boulevard APM station. This locations is outside the coverage area of Figure 4. A summary of this report is provided below.

Report of Fault Rupture Hazard Investigation, MACTEC, (MACTEC, 2003)

MACTEC performed a fault rupture hazard investigation within the eastern portion of the Los Angeles Southwest College campus, which is located in a delineated APEFZ.

MACTEC identified two zones of primary fault rupture associated with the Newport-Inglewood fault zone. A secondary splay of the Newport-Inglewood fault zone had been previously identified in the central portion of the campus between the existing Admission and Lecture/Lab buildings. The identified fault within the referenced portions of the Los Angeles Southwest College is situated approximately 2.3 miles southeast of the proposed Century Boulevard APM Station, outside the coverage area of Figure 4.

4.5 Metro

On 10 and 14 January 2019, Geosyntec contacted the Metro Records Management Center and submitted a public records request for potential fault investigations performed for the existing Crenshaw/LAX Transit Corridor Project (Crenshaw/LAX). Geosyntec also queried MTA's online Dorothy Peyton Gray Transportation Library and Archive and located a geotechnical investigation completed for the Crenshaw/LAX project [HMM, 2010].

The HMM report indicated a limited fault rupture study of the Newport-Inglewood fault zone was planned for the Florence/La Brea station to evaluate the locations of active traces of the Inglewood fault that were suspected to cross the Crenshaw/LAX project alignment in the vicinity of La Brea Avenue and the proposed Florence/La Brea station at that location. The fault investigation report [EMI, 2010] was subsequently located by Metro and provided to Geosyntec.

Additionally, subsequent to the identification of the EMI report, Metro provided two additional Crenshaw/LAX reports to the Meridian team. These reports: the Geotechnical Data Report (GDR) [HMM, 2012a] and Preliminary Geotechnical Engineering Design Technical Memorandum [HMM, 2012b] present detailed information related to the results of this investigation and development of related recommendations for the Crenshaw/LAX project.

The following sections provide details regarding the finding of these Crenshaw/LAX project reports and related discussions with Metro.

4.5.1 Earth Mechanics, Inc., [EMI, 2010]

The objective of the EMI fault investigation was to identify active traces of the Inglewood fault crossing the Crenshaw/LAX corridor at the location of the proposed Florence/La Brea station and its alternate site near the intersection of La Brea Avenue and Florence Avenue. The fault investigation consisted of performing geologic mapping, aerial-photograph analysis, geophysical surveys, and exploratory drilling. A summary of EMI's field investigation and their findings are provided in the subsections below.

4.5.1.1 Aerial Photography Analysis/Geologic Mapping

EMI completed a preliminary site reconnaissance on 15 June 2010 to confirm access for field exploration and assess information compiled from a records review of available geologic information. Additional geologic mapping was conducted on 10 September 2010 and samples from rock outcrop and soil exposures mapped north of the original Metro Florence/La Brea Station site (located northwest of the Market Street APM Station and Market Street Alternative for this project) were compared with samples from the geotechnical explorations.

An aerial photographic review of the pre-urban development setting for the area was performed utilizing stereographic historic aerial photograph sets from 1923, 1938 and 1952 to conduct a lineament evaluation. The lineament evaluation identified several linear topographic and vegetation features suspected to be a result of previous surface faulting. The identified lineaments were compared with previous published geologic maps [Bryant, 1988; Dibblee; 2007; and Poland et al., 1959] and revealed similarities in the locations of the linear features including the Centinela Creek, Inglewood Park Cemetery, Manchester Avenue, and Townsite faults (Figures 3 and 4).

4.5.1.2 Geophysical Survey

EMI's interpretation of seismic reflection profiles indicated two geophysical anomalies located west of La Brea Avenue that generally coincides with the mapped Inglewood fault and are within the designated APEFZ.

A third anomaly was identified on the east side of La Brea Avenue underlying a portion of the proposed alternate Florence/La Brea station (Figure 5 and 6). This geophysical anomaly was suggested to coincide with a splay of the southern Inglewood fault, or the Townsite fault identified by Poland et al. [1959] a feature which is not included in the APEFZ. Although exploratory drilling and cone penetrometer soundings (CPTs) completed for this investigation did not reveal any definitive information on faulting, EMI suggests the possibility of lateral displacement without large vertical offsets associated with the geophysical anomaly identified in the seismic reflection profiles could not be ruled out due to the strike-slip nature of the Newport-Inglewood fault zone.

4.5.1.3 Subsurface Drilling

As part of the geotechnical investigation, EMI conducted a subsurface drilling program, generally located along the Metro Line adjacent to Florence Avenue, consisting of six CPTs, one hollow-stem auger boring (HSA), and one angled core boring (Figure 5). As part of the evaluation they also included a review of one CPT and one HSA boring drilled

for a previous study for the Advanced Conceptual Engineering (ACE) phase of the geotechnical investigation [HMM, 2010].

The preliminary ACE explorations identified a predominance of sands with gravel east of the Inglewood fault and predominantly clayey and silty finer grained material to the west. The EMI drilling program encountered similar subsurface materials, but noted that neither the HSA boring nor CPT sounding provided definitive data on faulting. The angled core boring was advanced at a 45 degree inclination to intersect the geophysical anomaly zone east of La Brea Avenue, but data collection was hampered due to drilling challenges and spotty core recovery and ultimately the exploration was not able to further define the presence of faulting.

4.5.1.4 Conclusions and Recommendations

Evaluation of the seismic reflection profiles indicated potential zones of faulting on both the west and east sides of La Brea Avenue. These zones corresponds to both previously mapped APEFZ portions of the NISZ and as well as areas not mapped as part of the APEFZ which were designated as geophysical anomalies. However, the results of the drilling program were inconclusive as to the activity of the non-APEFZ delineated anomalies suspected to be faults.

4.5.2 Geotechnical Data Report, [HMM, 2012a]

The Geotechnical Data Report for Crenshaw/LAX project includes as an appendix a Fault Investigation report (Appendix L) which builds on the [EMI, 2010] investigation to provide input to the project, particularly regarding the location of the Florence/La Brea Station.

The report uses as its basis the concept that the California Building Code requires the avoidance of active faults at locations where life safety may be an issue. The report opines that if present “fault rupture [hazard] could be destructive to project facilities and could place human life in jeopardy, especially at elevated and subsurface boarding stations where people would congregate”. The report goes on to identify active faults as not only those which have an APEFZ established, but also those which are “considered to have been active in Holocene time by an authoritative source, or federal, state, or local government agency.”

Relative to the planned Florence/La Brea station, the report found that there are zones of potentially active faulting both east and west of La Brea Avenue as well as to the north and south. The report found that the geophysical “anomaly that essentially coincides with the Townsite fault” as identified by Poland et al [1959]. It continues: “Although the Townsite fault is not presently mapped as an Alquist-Priolo Earthquake Zone Fault, its

location within the active Newport-Inglewood Fault Zone, and its apparent intersection with the Newport-Inglewood Structural Zone, as well as recent earthquake activity, strongly suggest that it is a young fault with a potential for surface rupture.”

The report concludes that the Florence/La Brea station should be shifted to the east, away from the geophysical anomaly associated with the Townsite fault. The station was subsequently constructed to the east of the Townsite fault feature in compliance with these recommendations.

4.5.3 Preliminary Geotechnical Engineering Design Technical Memorandum [HMM, 2012b]

Section 5.1.4 of the Preliminary Geotechnical Engineering Design Technical Memorandum for the Crenshaw/LAX project provides input relative to fault rupture hazard. In conclusions similar to the Geotechnical Data Report [HMM, 2012a], the memorandum states, “Based on our current, limited understanding of the Newport Inglewood fault zone (NISZ) in the vicinity of the Florence/La Brea Station, with geophysical anomalies both to the east and west of the currently mapped AP zone, it seems likely that surface rupture may not be limited to the presently mapped AP zone.” It also presents the results of deterministic and probabilistic fault rupture displacement studies conducted.

The deterministic analysis conducted indicates that the NISZ is capable of producing “magnitude 7.1 earthquake which could generate an average of about 3.9 feet of displacement”. The “horizontal component of displacement could be about 3.0 to 3.1 feet with and the vertical component about 0.7 to 0.8 feet.” This is a conservative basis for the displacement across the entirety of the NISZ.

A probabilistic fault displacement hazard analysis was also conducted to establish a more definitive assessment of the hazard. This evaluation resulted in a “displacement hazard curve that would apply to any location along the alignment which is crossing a fault trace of the suite of individual faults which make up the Newport Inglewood fault zone.” Figure 5-12 of that report excerpted below presents that average surface displacement which could be anticipated along the fault zone for various return periods.

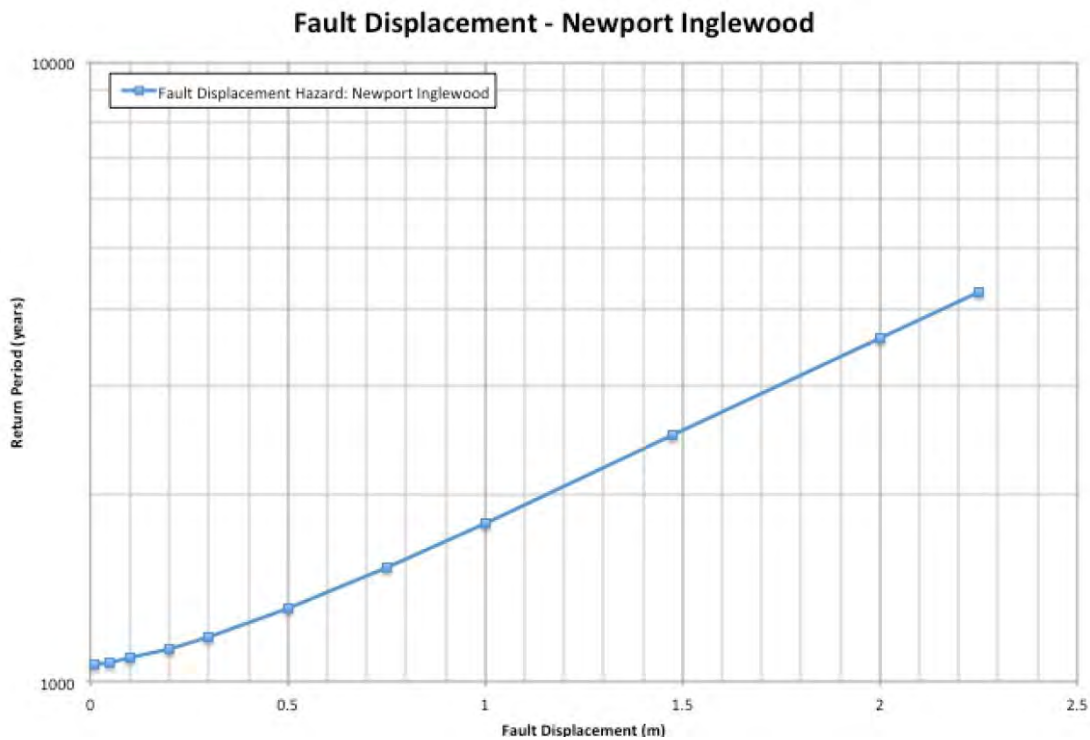

Fault Displacement Hazard Curve for the Metro Alignment Crossing the Newport- Inglewood Fault (Figure 5-12 from HMM, 2012B)

4.5.4 Discussions with Metro Technical Personnel

On 11 March 2019, Geosyntec participated in a phone conversation with Metro technical Androush Danielian (Executive Director-Project Engineering) and Namasivayam Sathialingam (Senior Director-Project Engineering) who are responsible for policy decisions related to fault rupture related design at Metro. During this call Metro’s engineers provided details regarding their design approach when fault rupture hazard is present. Metro anticipates that faults with the potential for rupture will need to be crossed by its rail lines including at bridges. Metro relies on two Caltrans standards, Memo to Designers 20-8 (Analysis of Ordinary Bridges that Cross Faults) [Caltrans, 2013a] and 20-10 (Fault Rupture) [Caltrans, 2013b]. Metro attempts to avoid locating structures which will be occupied (stations and maintenance facilities) at locations where fault rupture hazard is present due to increased potential life safety consequence.

Memo 20-8 provides a method for conducting structural evaluations of bridges at strike slip fault crossings based on design offset identified by criteria in 20-10 to confirm that the performance requirements outlined in Caltrans’ Seismic Design Criteria are met.

4.6 USGS

Geosyntec queried the USGS online library database on 10 January 2019. No previous fault investigations within the vicinity of the project were identified.

5. SUMMARY OF FINDINGS

5.1 Potential Fault Rupture Hazards Identified

The location of the geophysical anomaly west of La Brea Avenue and the general northwest-southeast trend of Newport-Inglewood fault zone indicates the Inglewood fault is present west of the project alignment. Given that previous fault investigations completed west of North Market Street (Figure 4) did not reveal evidence of faulting or surface rupture the potential for the Inglewood fault to cross the ITC alignment is considered low.

The geophysical anomaly identified east of La Brea Avenue and its suspected correlation with the mapped trace of the Townsite fault [Poland et al., 1959] which was considered potentially active as part of the HMM study conclusions, indicates the Townsite fault may intersect the project alignment and the Market Street Alternative, between Florence Avenue and East Manchester Boulevard (Figure 5). Although previous fault investigations completed south of Manchester Boulevard and west of North Prairie Avenue did not reveal evidence of faulting or surface rupture (Figure 5a), Poland et al., [1959] shows the trace of the Townsite fault continuing southeast and potentially crossing the alignment along Manchester Boulevard and North Prairie Avenue (Figure 4 and Figure 5a).

Although the Townsite fault is not presently mapped as a designated APEFZ fault, or situated within a delineated APEFZ, the location within the active Newport-Inglewood fault zone and surface expression suggests this fault should be considered active with the potential for surface rupture.

5.2 Initial Design Inputs

Specific information related to potential slip rates or maximum magnitudes associated with the Townsite fault is not available in published literature. In the absence of additional specific information related to activity of the Townsite fault, information developed from deterministic and probabilistic fault rupture displacement studies conducted by HMM [2012b] and conveyed in Section 4.5.3 of this report should be used as preliminary design inputs related to the potential magnitudes of fault rupture hazard for various return periods.

5.3 Data Gaps

Based upon the review of available information, additional studies are recommended to assess the location and level of activity along the anticipated trend of the Townsite fault (Figures 4, 5, and 5a) where it crosses the proposed ITC alignment between and through

the proposed Market Street APM Station and Market Street Alternative, the MST and East Tamarack Avenue, and the Forum APM Station and East Kelso Street. In the absence of the above information, the proposed stations and aerial structures will need to be designed with consideration of the potential presence of the anticipated trend of the Townsite fault.

6. CONCLUSIONS AND RECOMMENDATIONS

Fault rupture hazard was evaluated to assess the exposure to people or structures to substantial adverse effects, including the risk of loss, injury, or death. Based on review of available published geologic maps and previous fault hazard evaluations performed within the immediate vicinity of the project, the potential for surface fault rupture from the anticipated trend of the Townsite fault was identified in a portion of the proposed ITC alignment. Therefore, surface rupture from the anticipated trend of the Townsite fault due to faulting during the design life of the proposed base case and Market Street Alternative alignments is considered a potentially significant impact requiring mitigation.

Mitigation Measure 1

The proposed project should be designed to accommodate fault rupture where present in accordance with applicable Caltrans guidelines including Memo to Designers 20-8 (Analysis of Ordinary Bridges that Cross Faults), dated January 2013, and Memo to Designers 20-10 (Fault Rupture), dated January 2013 where any portion of a structure falls within an APEFZ, or where any portion of a structure falls within approximately 100 meters (330 feet) of well-mapped active faults, or within 300 meters (1,000 feet) of an un-zoned fault (not in an APEFZ) that is Holocene or younger in age, such as the anticipated trend of the Townsite fault.

Stations and elevated structures for the APM Guideway should be located to avoid the fault rupture hazard where present. As noted in Caltrans Memorandum to Designers (MTD) 20-8, bridge type structures, such as the APM Guideway, must be designed for the displacement demand resulting from a static fault offset, the dynamic response due to ground shaking, and any other fault-induced hazards (e.g., creep) that may occur at the site. Caltrans MTD 20-8 provides a method for obtaining the displacements at columns and abutments at fault crossings; all the requirements must also be followed. Adequate bearing seats must be provided so the superstructure can slide at the abutment, bent, or hinge seats without falling.

Mitigation Measure 2

Prior to the start of construction, the location of the anticipated trend of the Townsite fault should be further defined via a phased investigation process to identify and locate active fault traces in the project area to support adjustments to the proposed Project's design.

The Phase investigation should include a supplemental fault investigation conducted along the trace of the Townsite fault to further refine the location of the feature and assess the activity level where it crosses the proposed ITC alignment. This may include the following surface and subsurface methods:

- Aerial photograph analysis;
- Geophysical surveys (e.g., seismic reflection and seismic refraction) to refine the identified geophysical anomaly associated with the Townsite fault and inform subsequent targeted fault hazard exploration as necessary;
- Targeted fault trenching based on the findings of additional geophysical studies to locate the potential Townsite fault where it crosses the proposed ITC alignment and; and
- Exploratory drilling and sampling (e.g., hollow stem auger and CPT borings), as necessary, if definitive information regarding the trace of the Townsite fault cannot be adequately delineated across the proposed ITC alignment within the limits of fault trenching.

Based on the results of these investigations, column placements and facility designs may be adjusted to accommodate geologic conditions identified. Further, the facilities should be designed in accordance with applicable Caltrans guidelines including Memo to Designers 20-8 (Analysis of Ordinary Bridges that Cross Faults) and 20-10 (Fault Rupture). Stations/structures should be located to avoid the fault rupture hazard where present.

The design fault offset where evaluating features in close proximity to the stations or proposed structure alignment shall be determined as the larger of the:

- Deterministically derived average displacement.
- Probabilistically derived displacement consistent with a 5 percent in 50-years probability of exceedance.

Probabilistic procedures should follow those outlined in Abrahamson [2008] and Petersen et al., [2011]. These procedures allow for evaluation of offset based on the results of field investigation. If further study of the fault rupture is conducted, then procedures as outlined in CGS Note 49 shall be followed.

7. LIMITATIONS

The conclusions, recommendations, and opinions made herein are based on the assumption that subsurface conditions do not deviate appreciably from those found during the referenced previous investigations by others. This report has been prepared in accordance with current practices and the standard of care exercised by scientists and engineers performing similar tasks in this area. The conclusions contained in this report are based solely on the analysis of the conditions reviewed by Geosyntec personnel. We cannot make any assurances concerning the completeness of the data performed by others. This evaluation is not intended to replace site-specific geologic investigation in support of detailed engineering design for the Project.

No warranty, expressed or implied, is made regarding the professional opinions expressed in this report. If actual conditions are found to differ from those described in the report, or if new information regarding the site is obtained, Geosyntec should be notified and additional recommendations, if required, will be provided. Geosyntec is not liable for any use of the information contained in this report by persons other than Pacifica Services, Inc., or their subconsultants, or the use of information in this report for any purposes other than referenced in this report without the expressed, written consent of Geosyntec.

8. REFERENCES

- Abrahamson, N., 2008. “Probabilistic Fault Rupture Hazard Analysis,” San Francisco PUC, General Seismic Requirements for the Design on New Facilities and Upgrade of Existing Facilities, Appendix C.
- California Division of Mines and Geology (CDMG), 1998. “Seismic Hazard Zone Report for the Inglewood 7.5-Minute Quadrangle, Los Angeles County, California,” California Department of Conservation.
- California Geological Survey (CGS), 1999. “Earthquake Zones of Required Investigation – Inglewood Quadrangle,” 25 March 1999.
- Caltrans, 2013a. “Memo to Designers (MTD) 20-8, Analysis of Ordinary Bridges That Cross Faults.” January 2013.
- Caltrans, 2013b. “Memo to Designers (MTD) 20-10, Fault Rupture.” January 2013.
- Earth Mechanics, Inc., (EMI), 2010. “Phase 1 Preliminary Fault Investigation, La Brea Station, Crenshaw/LAX Transit Corridor, Los Angeles County, California.” December 2010.
- Geosyntec Consultants (Geosyntec), 2018. “Geology and Soils Technical Memorandum.” 3 July 2018.
- Hatch Mott MacDonald (HMM), 2010. “Preliminary Geotechnical Report – Crenshaw/LAX Transit Corridor Project,” October 2010.
- Hatch Mott MacDonald (HMM), 2012a. “Geotechnical Data Report, Volume 6: Technical Reports Part 6.2, Crenshaw/LAX Transit Corridor Project”, GDR prepared for LA County Metropolitan Transportation Authority dated March 2012.
- Hatch Mott MacDonald (HMM), 2012b. “Preliminary Geotechnical Engineering Design Technical Memorandum, Volume 8: Reference Documents, Part 8.1.12, Crenshaw/LAX Transit Corridor Project”, DTM prepared for LA County Metropolitan Transportation Authority dated March 2012.
- Jeffrey A. Johnson, Inc. (Johnson), 1988. “Preliminary Geologic Exploration Special Studies Zone Review, Proposed El Pollo Loco Restaurant, Southeast Corner of the Intersection of La Brea Avenue and Hazel Street, Inglewood, California.” 28 June 1988.
- MACTEC, 2003. “Report of Fault Rupture Hazard Investigation, Proposed Campus Master Plan, Los Angeles Southwest College Campus, 1600 West Imperial

Highway, Los Angeles, California prepared for the Los Angeles Community College District,” MACTEC Project No. 70131-2-0129.

Meridian Consultants (Meridian), 2018. “Inglewood Transit Connector Project – Initial Study,” July 2018.

Peterson, M., and others, 2011. “Fault Displacement Hazard for Strike-Slip Faults,” Bulletin of the Seismological Society of America, Vol. 101, No. 2, pp. 805-825.

State of California, 2017. “Digital Archive of Geotechnical Data (GeoDOG),” California Department of Transportation Website, accessed 19 December 2018.
<https://geodog.dot.ca.gov/>

United States Geologic Survey (USGS), 2018. “Quaternary Fault and Fold Database of the United States,” USGS Website accessed April 2018.
<https://earthquake.usgs.gov/hazards/qfaults/>

United States Geological Survey (USGS), 2008, “2008 National Seismic Hazard Maps – Source Parameters for Newport-Inglewood, alt 1”, USGS Website accessed April 2018.
https://earthquake.usgs.gov/cfusion/hazfaults_2008_search/view_fault.cfm?cfault_id=127ab

TABLE

**Table 1. Summary of Previous Fault Investigations
Inglewood, California**

AP File No. ¹	Address	APN ²	Investigation Report Date	Site Investigation Date	Distance from ITC Alignment (ft) ³	Fault Found	Exploration Trench(s) Performed	Boring(s) Performed	Geophysics Performed	Reference	Reference Source ⁴
0365	301 N Prairie Ave	4015-024-021	6/18/1976	May and June 1976	1,850	No	No	Yes	No	LeRoy Crandall & Associates, 1976	CGS
0418	333 N Prairie Ave	4015-024-023	12/26/1974	NA	240	No	No	Yes	No	Glenn A. Brown & Associates, 1974	CGS
0593	330 E Florence ve	4015-027-029	11/9/1977	11/1/1977	400	No	Yes	No	No	LeRoy Crandall & Associates, 1977	CGS
0873	630 E Regent St	4021-001-051	10/12/1978	9/13/1978	1,200	No	Yes	No	No	Foundation Engineering, 1978	CGS
0931	250 W Ivy Ave	4016-030-015	2/2/1979	NA	1,000	No	No	Yes	No	Leighton & Associates, 1979	CGS
1129	110 N La Brea Ave	4021-008-034	2/21/1979	NA	210	No	Yes	Yes	No	LeRoy Crandall & Associates, 1979	CGS
1201	333 N Prairie Ave	4015-024-023	12/26/1974	NA	240	No	Yes	No	No	Glenn A. Brown & Associates, 1974	CGS
1223	741 E Nutwood St	4021-036-051	7/21/1980	NA	260	No	Yes	No	No	Hu Associates, 1980	CGS
1282	136 W Beach Ave	4016-030-002	10/28/1980	NA	1,050	No	Yes	No	No	Baseline Consultants, 1980	CGS
1283	3700 W Manchester Blvd	<i>More than 100 parcels with separate APNs</i>	5/16/1979	NA	1,150	No	Yes	Yes	No	GeoSoils, 1979	CGS
1400	319-323 N Market Street	4016-028-006	10/1/1981	NA	1,150	No	Yes	No	No	C. Michael Scullin, 1981	CGS
		4016-028-007									
		4016-028-005									
		4016-028-003									
		4016-028-015									
1433	128 N Hillcrest Blvd	4021-003-012	2/10/1982	NA	740	No	Yes	No	No	Baseline Consultants, 1982	CGS
1434	407 N La Brea Ave	4016-024-011	2/24/1982	NA	1,100	No	Yes	No	No	Baseline Consultants, 1982	CGS
1454	Southwest corner of Hazel St and La Brea Ave	4016-024-027	1/22/1982	NA	1,300	No	Yes	No	No	Baseline Consultants, 1982	CGS
1477	Southwest corner of Manchester Boulevard and Prairie Avenue	4021-036-049	8/9/1982	9/2 and 9/3/1982	20	No	Yes	No	No	California Geo-Systems, 1982	CGS
1619	3111 W Century Blvd	4025-017-023	9/20/1983	NA	5,000	No	Yes	No	No	Harley Tucker, Inc., 1983	CGS, City
3257 ⁵	3111 W Century Blvd	4025-017-023	9/3/2002	8/26/2002	5,000	No	Yes	Yes	No	Strata-Tech, Inc., 2002	CGS, City
1629 ⁵	808 E Kelso St	4021-038-026	10/7/1983	10/6/1983	230	No	Yes	No	No	C. Michael Scullin, 1983	CGS
1698	116 W Hazel St	4016-024-026	6/11/1984	4/11/1984	1,300	No	Yes	No	No	California Geo-Systems, 1984	CGS
1719	514 S Osage Ave	4021-037-006	5/3/1984	4/20/1984	240	No	Yes	No	No	Soils International, 1984	CGS
1763	519 & 523 Manchester Ter	4021-005-038	11/14/1984	9/25/1984	180	No	Yes	No	No	AAKO Geotechnical Engineering Consultants, 1984	CGS
1769	106 E Manchester Blvd	4021-014-905	2/18/1985	2/5/1985	640	No	Yes	Yes	No	Lockwood-Singh & Associates, 1985	CGS
1813	3612/3624 W Century Blvd	4032-004-045	7/10/1985	7/9/1985	1,700	No	Yes	No	No	California Geo-Systems, 1985	CGS
1820	409 Grace Ave	4015-021-044	8/5/1985	7/12 and 7/15/1985	620	No	Yes	No	No	Kovacs-Byer & Associates, 1985	CGS
1830	625 S Osage Ave	4021-039-003	8/16/1985	NA	470	No	Yes	No	No	California Geo-Systems, 1985	CGS
1851	515 N Market St	4016-018-002	11/8/1985	10/17/1985	1,700	No	Yes	No	No	Soils International, 1985	CGS
1852	105 & 109 N Eastwood Ave	4021-003-025	11/11/1985	10/15/1985	550	No	Yes	No	No	Soils International, 1985	CGS
		4021-003-026									
1926	Nutwood St and Tamarack Ave	4021-028-007	4/16/1986	NA	160	No	Yes	No	No	Geolabs-Westlake Village, 1986	CGS
		4021-028-030									
		4021-028-118									
		4021-028-169									
		4021-028-235									
1933	110 S La Brea Ave	4021-009-037	12/30/1985	July and December 1985	60	No	No	Yes	No	LeRoy Crandall & Associates, 1985	CGS
2117	510 N La Brea Ave	4016-019-003	11/21/1987	11/3, 11/12, and 11/13/1987	1,500	No	Yes	No	No	C.A. Richards, 1987	CGS
	109 E Hazel St	4016-019-005									
	125 E Hazel St	4016-019-006									
	502 N La Brea Ave	4016-019-013									
2165	514 N Market St	4016-017-004	6/15/1988	6/14/1988	1,800	No	Yes	No	No	Ray A. Eastman (The Geologic Outfit), 1988	CGS
2187	SE corner of La Brea Ave and Hazel St	4016-025-002	6/28/1988	NA	1,350	Yes	Yes	No	No	Jeffrey A. Johnson, 1988	CGS
		4016-025-003									
2316	South of 90th St (Pincay Dr) and west of Darby Park	<i>More than 100 parcels with separate APNs</i>	10/30/1986	NA	2,500	No	Yes	No	No	Kenneth G. Osborne & Associates, 1986	CGS
2446	410 N La Brea Ave	4016-025-006	6/19/1990	6/5/1990	1,150	No	Yes	No	No	Kovacs-Byer & Associates, 1990	CGS
2753 ⁵	1600 W Imperial Highway	6079-001-904	12/8/1989	11/1, 11/2, 11/3, and 11/10/1989	11,800	No	Yes	Yes	No	LeRoy Crandall & Associates, 1989	CGS
NA ⁵	1600 W Imperial Highway	6079-001-904	6/25/1905	NA	11,800	Yes	NA	NA	NA	MACTEC, 2003	On-line
NA ⁵	1600 W Imperial Highway	6079-001-904	7/30/2004	6/17/2004	11,800	No	No	Yes	No	Leighton Consulting, Inc., 2004	LACDPW
NA ⁵	1600 W Imperial Highway	6079-001-904	12/21/2005	11/2, 11/3, 11/4, 11/7, 11/8, and 11/9/2005	11,800	No	No	Yes	No	MACTEC, 2005	LACDPW
3166	3363 W Century Blvd	4025-020-003	10/20/1999	10/6 and 10/7/1999	2,500	No	Yes	No	No	CFS Geotechnical Consultants, 1999	CGS, City
3320	SW corner of 11th Street and Century Boulevard	<i>More than 15 parcels with separate APNs</i>	1/10/2005	NA	3,280	No	No	No	No	Geosols, Inc., 2005	CGS
3394	200 N La Brea Ave	4015-028-900	10/22/2007	8/2/2007 and 9/21/2007	195	No	Yes	No	No	Southwest Geotechnical Inc., 2007	CGS, City
		4015-028-901									
		4015-028-902									
		4015-028-903									
		4015-028-904									
		4015-028-905									
		4015-028-906									
		4015-028-907									
		4015-028-908									
4015-028-909											
NA	Crenshaw/LAX Transit Corridor Project - La Brea Station	4016-030-900	12/1/2010	8/27, 8/28, and 8/29/2010; 9/8/2010; 11/1, 11/2, 11/3, 11/4, and 11/5/2010	150	Yes	No	Yes	Yes	Earth Mechanics Inc., 2010	Metro

Notes:





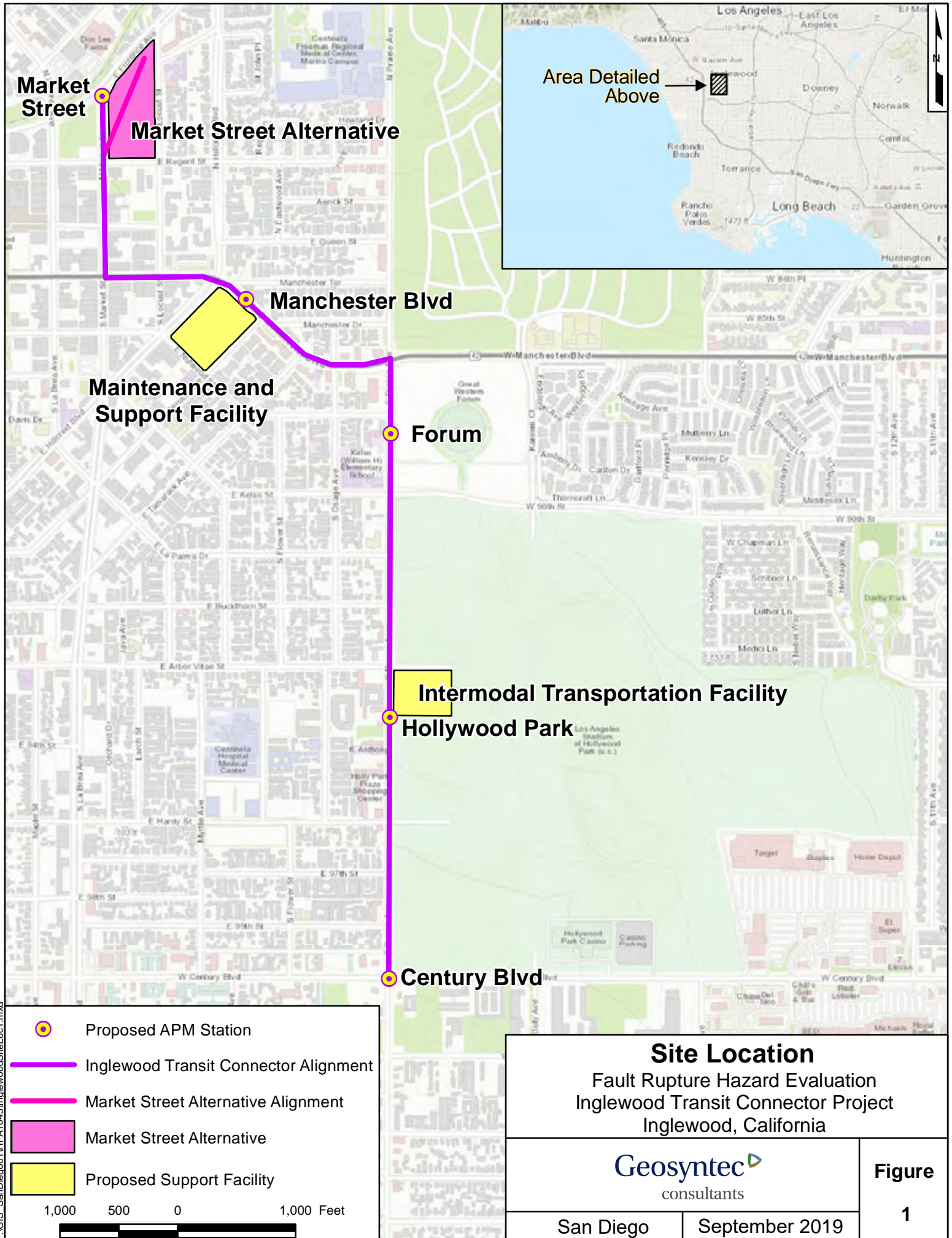

- 1 - A-P File Numbers provided in the California Geological Survey "A-P Site Investigation Database" (.kml file)
 - 2 - Assessor's Parcel Number (APN)
 - 3 - Distances listed are approximate and were measured in GoogleEarth
 - 4 - California Geological Survey (CGS), City of Inglewood Building and Safety Division (City), Los Angeles County Department of Public Works (LACDPW), Los Angeles County Metropolitan Transportation Authority (Metro), On-line data search (On-line)
 - 5 - Not presented on Figure 3. Location of the previous investigation is outside the mapview
- Shaded cells denote where evidence of faulting was identified during previous investigation
- "NA" - Not available

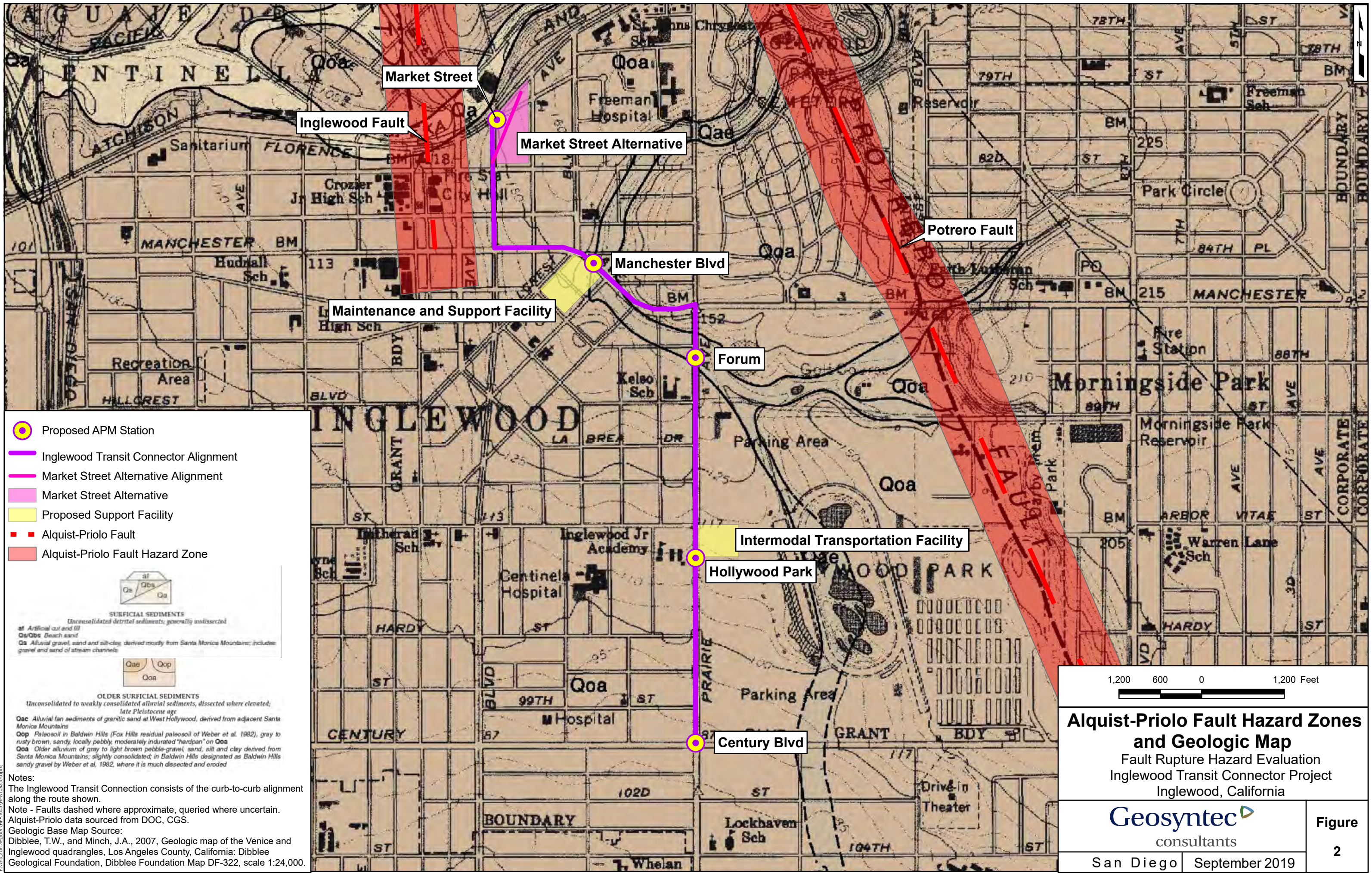
FIGURES



P:\GIS_SanDiego\01\HPA1043\InglewoodSiteLoc1.mxd



-  Proposed APM Station
-  Inglewood Transit Connector Alignment
-  Market Street Alternative Alignment
-  Market Street Alternative
-  Proposed Support Facility
-  Alquist-Priolo Fault
-  Alquist-Priolo Fault Hazard Zone

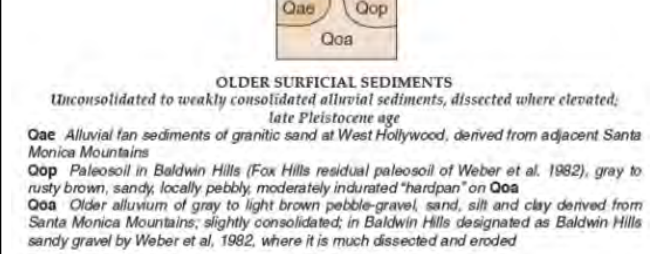
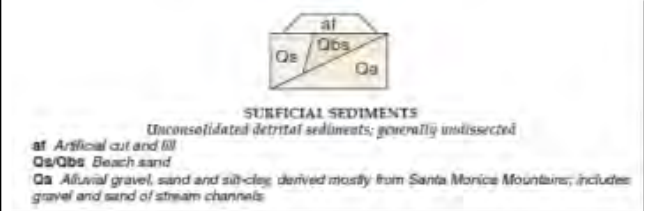

Notes:
 The Inglewood Transit Connection consists of the curb-to-curb alignment along the route shown.
 Note - Faults dashed where approximate, queried where uncertain.
 Alquist-Priolo data sourced from DOC, CGS.
 Geologic Base Map Source:
 Dibblee, T.W., and Minch, J.A., 2007, Geologic map of the Venice and Inglewood quadrangles, Los Angeles County, California: Dibblee Geological Foundation, Dibblee Foundation Map DF-322, scale 1:24,000.

1,200 600 0 1,200 Feet







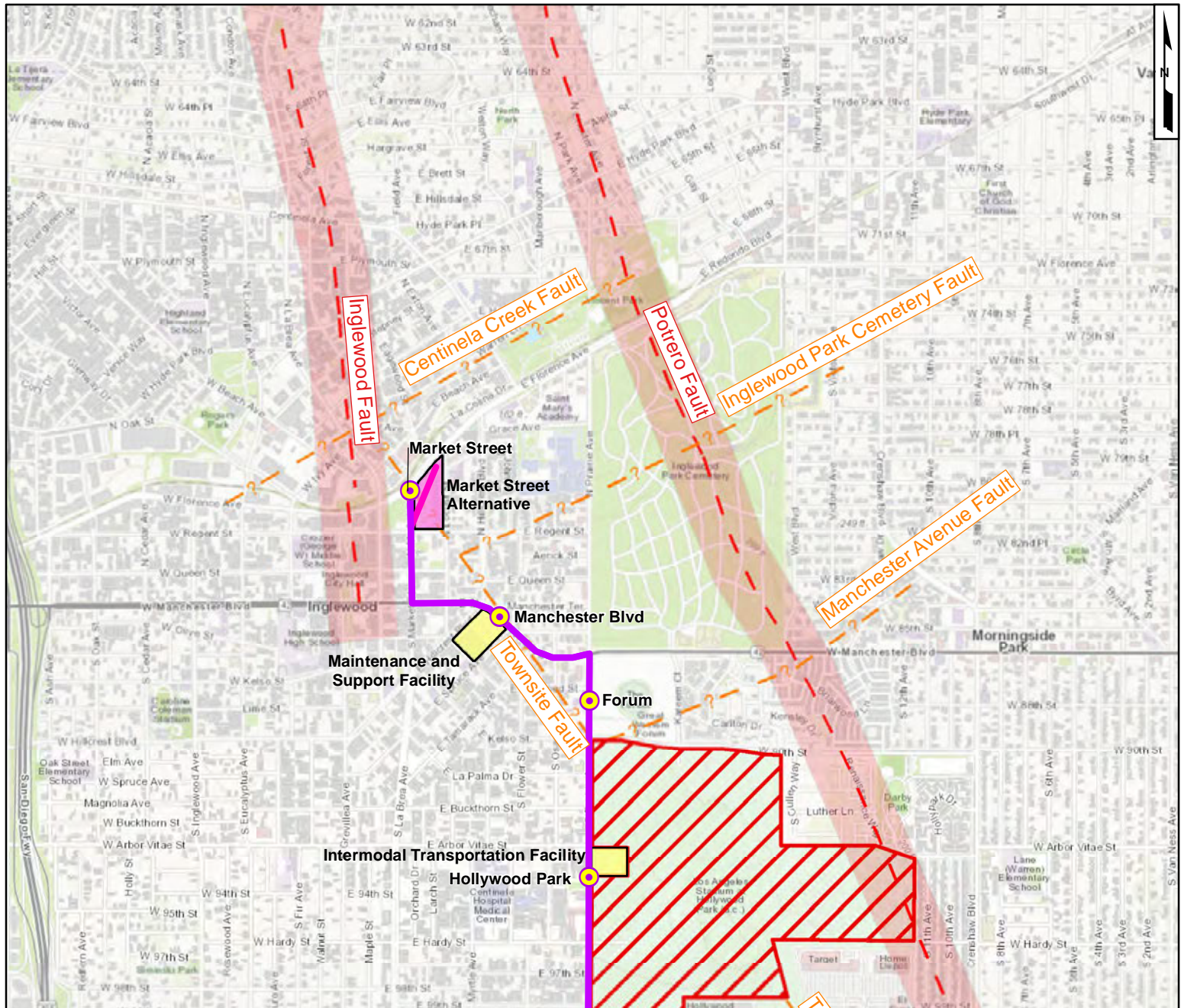

Alquist-Priolo Fault Hazard Zones and Geologic Map
 Fault Rupture Hazard Evaluation
 Inglewood Transit Connector Project
 Inglewood, California

Geosyntec consultants

San Diego | September 2019

Figure 2



-  Proposed APM Station
-  Inglewood Transit Connector Alignment
-  Market Street Alternative Alignment
-  Market Street Alternative
-  Proposed Support Facility
-  Fault (Poland et al 1959)
-  Alquist-Priolo Fault
-  Alquist-Priolo Fault Hazard Zone
-  Area of Current Ram's Stadium Development (Site-specific seismic analysis expected to have been performed, but not available at this time)

Note - Faults dashed where approximate, queried where uncertain.
Alquist-Priolo data sourced from DOC, CGS.



Fault Map

Fault Rupture Hazard Evaluation
Inglewood Transit Connector Project
Inglewood, California

P:\GIS_SanDiego\11HPA1043\Inglewood\Site\Loc\Updated\Faults1.mxd

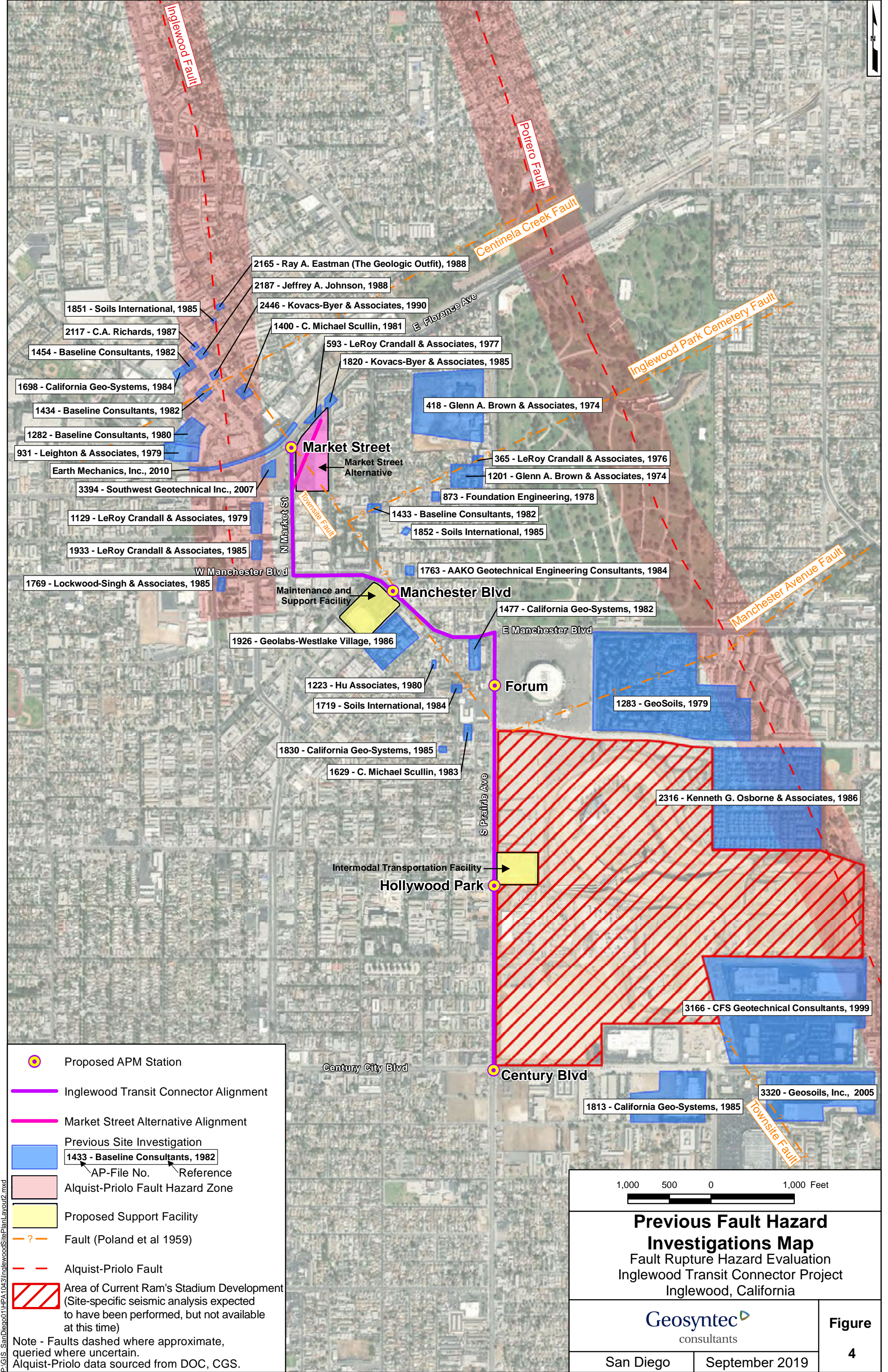

F:\GIS_SanDiego\1\HPA\1043\Inglewood\SitePlan\Layout2.mxd

- Proposed APM Station
 - Inglewood Transit Connector Alignment
 - Market Street Alternative Alignment
 - Previous Site Investigation
 - 1433 - Baseline Consultants, 1982
AP-File No. Reference
 - Alquist-Priolo Fault Hazard Zone
 - Proposed Support Facility
 - Fault (Poland et al 1959)
 - Alquist-Priolo Fault
 - Area of Current Ram's Stadium Development
 (Site-specific seismic analysis expected to have been performed, but not available at this time)
- Note - Faults dashed where approximate, queried where uncertain.
 Alquist-Priolo data sourced from DOC, CGS.

1,000 500 0 1,000 Feet

Previous Fault Hazard Investigations Map
 Fault Rupture Hazard Evaluation
 Inglewood Transit Connector Project
 Inglewood, California

	Figure
San Diego	September 2019
4	

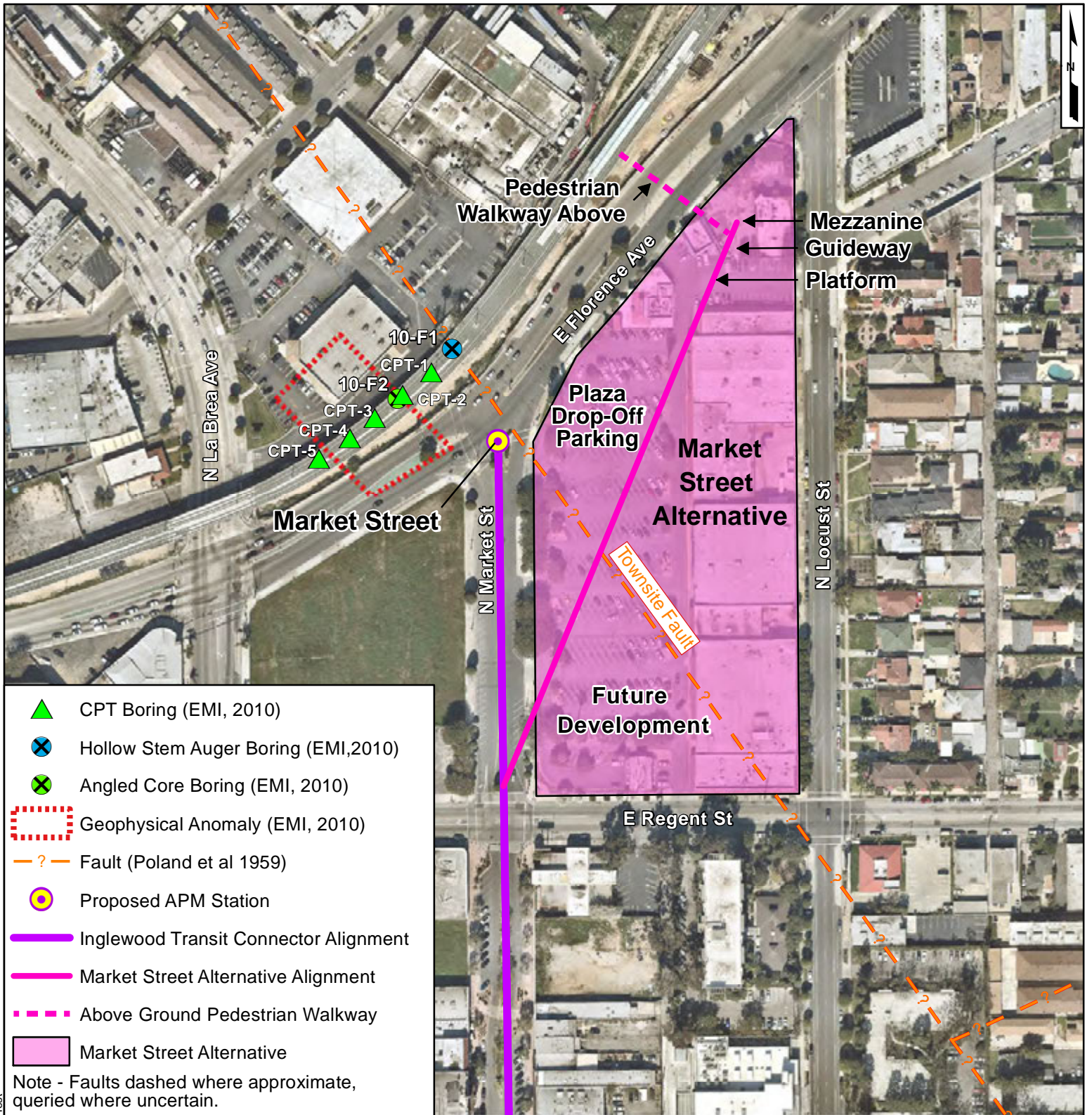

- ▲ CPT Boring (EMI, 2010)
- ⊗ Hollow Stem Auger Boring (EMI, 2010)
- ⊗ Angled Core Boring (EMI, 2010)
- Geophysical Anomaly (EMI, 2010)
- ? - Fault (Poland et al 1959)
- Proposed APM Station
- Inglewood Transit Connector Alignment
- Market Street Alternative Alignment
- Above Ground Pedestrian Walkway
- Market Street Alternative

Note - Faults dashed where approximate, queried where uncertain.

P:\GIS_SanDiego\1\HPA1043\Inglewood\NorthMarketSt.mxd_Test

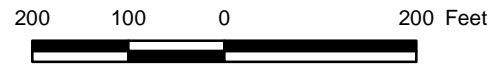
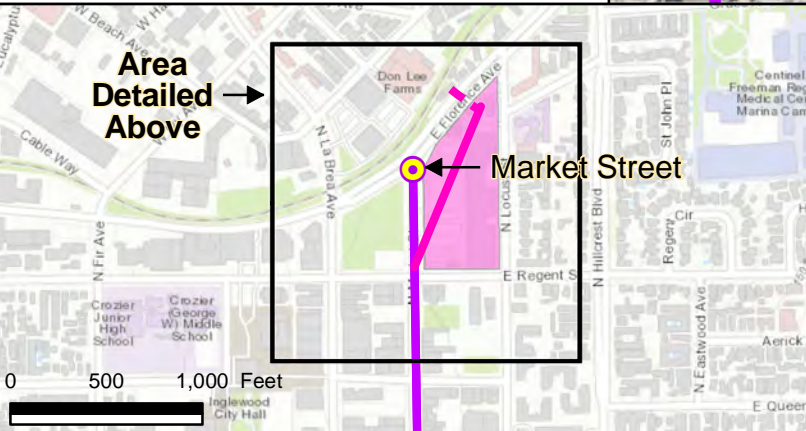

Market Street Alternative
 Fault Rupture Hazard Evaluation
 Inglewood Transit Connector Project
 Inglewood, California



Figure

5

San Diego

September 2019

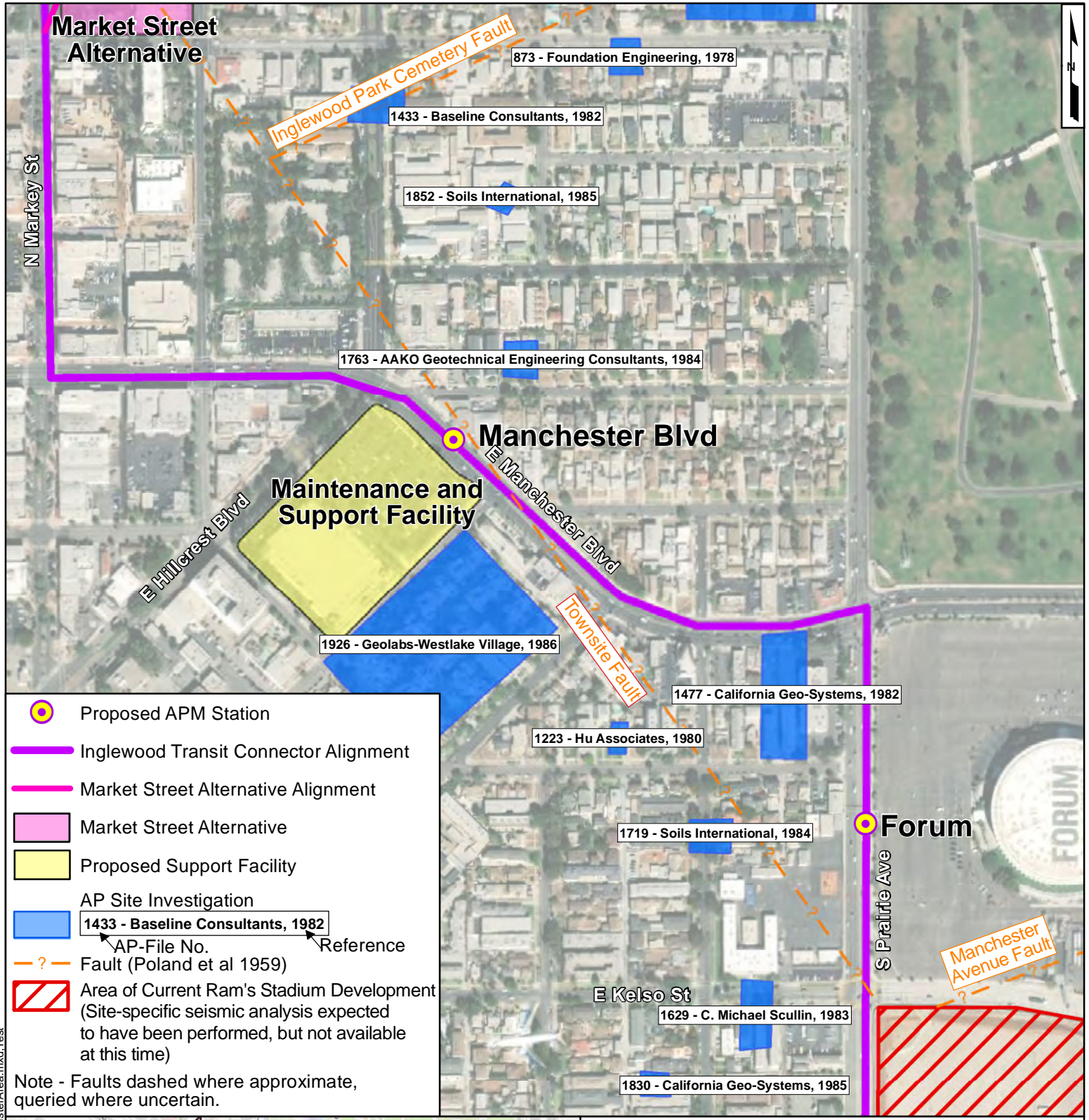

- Proposed APM Station
 - Inglewood Transit Connector Alignment
 - Market Street Alternative Alignment
 - Market Street Alternative
 - Proposed Support Facility
 - AP Site Investigation
 - 1433 - Baseline Consultants, 1982
 - AP-File No. Reference
 - Fault (Poland et al 1959)
 - Area of Current Ram's Stadium Development (Site-specific seismic analysis expected to have been performed, but not available at this time)
- Note - Faults dashed where approximate, queried where uncertain.

P:\GIS - San Diego\01\HPA1043\Inglewood\1959\Faults\ManchesterArea.mxd, Test

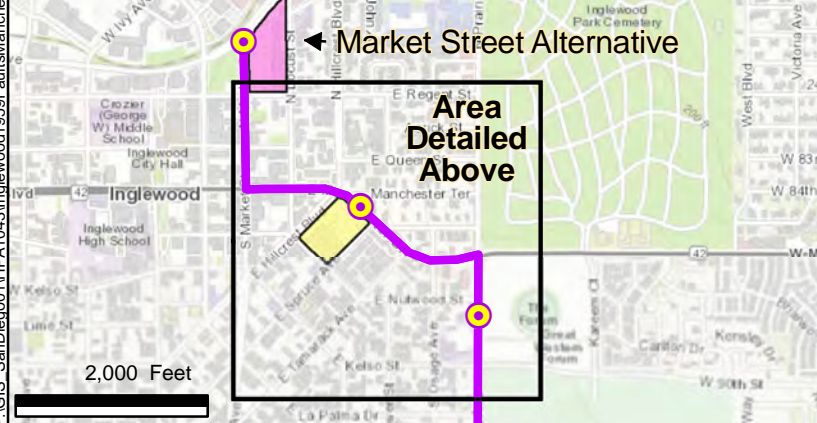

Townsite Fault
 Fault Rupture Hazard Evaluation
 Inglewood Transit Connector Project
 Inglewood, California

		Figure 5a
San Diego	September 2019	



K.2

Seismic Design Criteria





Prepared for:

Pacifica Services, Inc.
106 South Mentor Avenue, Suite 200
Pasadena, California 91106

**DEVELOPMENT OF SEISMIC DESIGN
CRITERIA IN SUPPORT OF DRAFT EIR
INGLEWOOD TRANSIT CONNECTOR
PROJECT
INGLEWOOD, CALIFORNIA**

Prepared by:



engineers | scientists | innovators

65 North Raymond Avenue, Suite 200
Pasadena, California 91103

Project Number HPA1043-05

26 June 2019

DEVELOPMENT OF SEISMIC DESIGN CRITERIA IN SUPPORT OF DRAFT EIR

Inglewood Transit Connector Project Inglewood, California

This report was prepared under the supervision
and direction of the undersigned.

Prepared by:

Geosyntec Consultants, Inc.

2100 Main Street, Suite 150
Huntington Beach, CA 92648



Glenn Rix, Ph.D.
Senior Principal



Chris Conkle, P.E., G.E.
Senior Engineer

TABLE OF CONTENTS

1.	INTRODUCTION	1
	1.1 Project Description	1
	1.2 Objective and Scope of Services	2
2.	DISCUSSION OF APPLICABLE SEISMIC DESIGN STANDARDS	3
	2.1 Review of Seismic Design Standards	3
	2.2 Selection of Metro Supplemental Seismic Design Criteria	3
	2.3 Recommended Two-Level Ground Motion Approach	3
	2.4 Design Objectives	4
3.	DEVELOPMENT OF DESIGN RESPONSE SPECTRA	6
	3.1 Introduction	6
	3.2 Site Conditions	6
	3.3 Probabilistic Seismic Hazard Spectra	6
	3.3.1 Metro Supplemental Seismic Design Criteria	6
	3.3.2 Caltrans Seismic Design Criteria	7
	3.3.3 California Building Code 2016	7
4.	RECOMMENDED DESIGN RESPONSE SPECTRA	8
5.	LIMITATIONS	9
6.	REFERENCES	10

TABLE OF CONTENTS (Continued)

LIST OF TABLES

Table 1: Summary of Design Criteria

Table 2: Summary of Recommended Response Spectra

LIST OF FIGURES

Figure 1: Site Location Map

Figure 2: Quaternary Geologic Map of the Inglewood Quadrangle (from CDMG, 2006)

Figure 3: Mean Vs30 Map (from CGS, 2019)

Figure 4: Design Response Spectra

LIST OF APPENDICES

Appendix A: Metro Supplemental Seismic Design Criteria

1. INTRODUCTION

This summary report has been prepared by Geosyntec Consultants, Inc. (Geosyntec) for Pacifica Services, Inc. (Pacifica) to present the findings of a desktop-level evaluation of appropriate seismic design criteria and preliminary estimation of corresponding design response spectra in support of the Draft Environmental Impact Report (EIR) for the proposed Inglewood Transit Connector Project (the ITC; Project) in Inglewood, California. This report was prepared by Dr. Glenn J. Rix and reviewed by Mr. Christopher Conkle, P.E., G.E., of Geosyntec, in accordance with the peer review policy of the firm.

1.1 Project Description

The City of Inglewood (City) is in the process of developing an automated people mover system (APM) titled the Inglewood Transit Connector (the ITC) project that would provide a transit connection from downtown Inglewood and the Metro Crenshaw/LAX line to the City's major activity centers, including the Forum, the Los Angeles Stadium and Entertainment District (LASED), and the proposed Inglewood Basketball and Entertainment Center (IBEC).

Pacifica Services, Inc. (prime contractor with the City) team is preparing an EIR under the requirements of the California Environmental Quality Act (CEQA) to support the Project.

Per the ITC Project Initial Study, released in July 2018, the Project will consist of an elevated APM system. The length of the proposed APM system is approximately 1.8 miles, extending southward from the Market Street/Metro Crenshaw Line connection along South Market Street, continuing eastward along East Manchester Boulevard, southward along North Prairie Avenue, and terminating at the intersection of West Century Boulevard and Prairie Avenue located adjacent to the LASED and IBEC (Figure 1). In addition to dual aerial guideways, the project will also consist of five APM Stations (ICS), a Maintenance and Storage Facility (MSF) and an Intermodal Transportation Facility (ITF). Potential locations of these facilities are shown on Figure 1.

An alternative to the base project description is also being considered which relates to a parcel at the southeastern corner of Market Street and Florence Avenue. This alternative is referred to as the "Market Street Alternative." At the location identified in Figure 1, the Market Street Alternative would include an alternate guideway alignment near the northern terminal of the line, a pedestrian walkway connecting to the Metro Florence/La Brea Station, an above-ground mezzanine, vehicle parking, and potentially commercial and residential development. A combined evaluation of both the base Project and Market Street Alternative is presented in this report.

CEQA Guidelines indicate that a project would be impacted by a seismic event if it were to “expose people or structures to potential substantial adverse effects, including the risk of loss, injury, or death, involving strong seismic ground shaking.” Southern California is a seismically active region with numerous faults capable of causing strong seismic ground shaking at the site. This is a potentially significant impact requiring mitigation.

1.2 Objective and Scope of Services

The objective of this desktop-level evaluation was to provide information regarding the appropriate seismic design criteria for the Project, along with a preliminary evaluation of the corresponding ground shaking intensities. This evaluation is not intended to replace a site-specific seismic hazard evaluation in support of detailed engineering design for the Project.

Professional services in support of this Project were performed in accordance with our approved proposal, dated 21 September 2018. The scope of services included the following:

- Review applicable guidance;
- Develop seismic design criteria and design response spectra; and
- Preparation of this report.

2. DISCUSSION OF APPLICABLE SEISMIC DESIGN STANDARDS

2.1 Review of Seismic Design Standards

To identify appropriate seismic design standards for the project, the following design standards were reviewed as part of the preparation of this report.

1. California Building Code (CBC), 2016, Title 24, Part 2, Volumes 1 and II; California Building Standards Commission and International Code Council. (Including local amendments and guidelines) [CBC, 2016].
2. American Society of Civil Engineers, Structural Engineering Institute (ASCE/SEI), 2017; Minimum Design Loads and Associated Criteria for Buildings and other Structures, ASCE/SEI 7-16, (including errata)
3. Caltrans Seismic Design Criteria (SDC), Version 1.7, April 2013
4. American Association of State Highway and Transportation Official (AASHTO) Load and Resistance Factor Design (LRFD) Bridge Design Specifications, 8th Edition, November 2017 with California Amendments.
5. AASHTO Guide Specifications for LRFD Seismic Bridge Design, 2nd Edition with 2015 Interim Revisions.
6. Metro Supplemental Seismic Design Criteria (MSSDC), Revision 4. [Metro, 2012]

2.2 Selection of Metro Supplemental Seismic Design Criteria

After review of applicable guidance with respect to development of seismic design criteria and selection of design ground motions, the approach recommended in the MSSDC, Revision 4 [Metro, 2012] or the most current version of this guidance available at the time of the design is recommended for adoption by the Project. This document, referred to as MSSDC, is included as Appendix A. The MSSDC has been developed for use in the local area on projects similar to the ITC and provides a consistent framework for evaluating both planned aerial structures as well as ancillary surface facilities. It is thus recommended as an appropriate basis for design of this Project.

2.3 Recommended Two-Level Ground Motion Approach

The MSSDC seismic design criteria is a probabilistic design approach with two levels and an assumed design life of 100 years as follows per Metro (2012):

1. “An operating design earthquake (ODE) defined as an earthquake event likely to occur only once in the design life.”
2. “A maximum design earthquake (MDE) defined as an earthquake event with a low probability of occurring in the design life.”

The probabilistic seismic ground motion criteria associated with each level are as follows:

- ODE: 50% probability of exceedance in 100 years (144-year return period); and
- MDE: 4% probability of exceedance in 100 years (2,475-year return period).

For the assumed 100-year design life of the ITC, the MDE approximately represents the return period used to design new buildings and is similar to ground motion return periods selected for other similar recent transit projects. The ODE is similar to the operations-level design used for various recent transit projects. Further rationale for the Metro’s adoption of this two-level policy may be found in Section 1.2 of the MSSDC.

2.4 Design Objectives

The objectives in selecting the design criteria are outline in Section 1.3.2 of the MSSDC and are shared by the ITC Project. These objectives are summarized as follows [Metro, 2012]:

- ODE: “structures should be designed to respond without significant structural damage, the low level of damage that may occur shall be repairable during normal operating hours.”
- MDE: “the structure should be designed to survive the deformation imposed, avoid major failure, and maintain life safety. The objective is to provide adequate strength and ductility to prevent collapse of the structure. The extent of the structure damage should be limited to what is visible and repairable.”

The ITC Project will consist of bridge structures supporting aerial guideways as well as ancillary surface facilities. The following are special considerations related to each of these project elements. These criteria are summarized in Table 1.

Aerial Guideways and Bridges

Per Metro (2012), for “bridges and aerial guideways, the design shall not result in less seismic performance capability than that required by Caltrans.” As such, ground motions developed for the ITC Project in accordance with the MDE level should be compared to

the Caltrans design spectrum per Caltrans SDC, Version 1.7, April 2013, and the more critical design load should govern.

Ancillary Surface Facilities

Per Metro (2012), ancillary surface facilities, such as the planned stations, the MSF, and the ITF may be “subject to both the code forces normally applied to surface buildings [CBC, 2016] as well as those being applied to the transit guideways. Whichever code applies the most critical set of requirements shall apply to the design.”

Elements of the proposed Project, including ITC-related buildings and the potential commercial/residential development as part of the Market Street Alternative will be subject to review by the local building official, in this case, the City. As such, ground motions developed for the ITC Project in accordance with the MDE level should be compared to the CBC 2016, Title 24, Part 2, Volumes 1 and II, and the more critical design load should govern. In the case where commercial/residential structures are unrelated to or not connected to the ITC guideway or support buildings directly, the use of CBC 2016 design response spectra may be an appropriate basis for design at the discretion of the design engineer.

3. DEVELOPMENT OF DESIGN RESPONSE SPECTRA

3.1 Introduction

Based on the seismic design criteria discussed, corresponding design response spectra were developed for the aerial guideway structures and the building structures and ancillary surface facilities. The development of these response spectra was based on mapped values of ground motion for firm-ground site conditions. These ground motions were adjusted for near-fault effects, basin amplification, and local site effects.

The following sections describe the process for the development of these elements for each of the relevant ground motion criteria.

3.2 Site Conditions

The Project is located within the Inglewood quadrangle as shown in Figure 2 [CDMG, 2006]. The proposed APM system and MSF are located within a surface geologic unit designated as “older alluvium (Qoa),” which is described as stiff to hard clay and medium dense to very dense sand, silty sand, clayey sand, and silt.

Figure 3 shows the distribution of the mean of the time-averaged shear wave velocity within the upper 30 meters (V_{s30_mean}) in the areas surrounding the ITC [CGS, 2019]. As indicated in the figure, the V_{s30_mean} along the alignment of the proposed APM system and MSF is 386.6 m/sec. Soils with this value of V_{s30} are generally considered to be “very dense soil and soft rock,” which is consistent with the description of the Qoa surface geologic unit above.

3.3 Probabilistic Seismic Hazard Spectra

Brief summaries are provided below of the methodology used to develop the design spectra based on the MSSDC, Caltrans SDC, and CBC.

3.3.1 Metro Supplemental Seismic Design Criteria

Although the MSSDC references the 2008 version of the U.S. Geological Survey National Seismic Hazard Maps, this version is considered obsolete as of the date of this report. Instead, Geosyntec used current versions of the seismic source characterization (SSC) and ground motion characterization (GMC) to develop probabilistic design spectra for the ODE and MDE. The SSC is based on the Uniform California Earthquake Rupture Forecast Version 3.0 [UCERF3, Field et al., 2013]. UCERF3 is a joint undertaking of the U.S. Geological Survey (USGS), the California Geological Survey (CGS), and the Southern California Earthquake Center (SCEC), with support from the California

Earthquake Authority (CEA). The GMC is based on the Next Generation Attenuation (NGA) West-2 ground motion prediction equations (GMPEs). The four GMPEs used along with their associated weights are as follows:

1. Abrahamson, Silva, and Kamai (0.25);
2. Boore, Stewart, Seyhan, and Atkinson (0.25);
3. Campbell and Bozorgnia (0.25); and
4. Chiou and Youngs (0.25).

Kamai and Abrahamson (2015) have determined that no corrections to spectral parameters to account for near-fault effects are necessary for NGA West-2 GMPEs.

The design response spectral values were obtained from the *OpenSHA Hazard Spectrum Calculator v.1.4.0* [Field et al., 2003] using the mean UCERF3 earthquake-rate model. Basin effects were included by specifying the depths to $V_s = 1.0$ km/s and 2.5 km/s of 563 m and 3.41 km, respectively, for use in the GMPEs.

3.3.2 Caltrans Seismic Design Criteria

The Caltrans response spectra were calculated using the Caltrans ARS Online tool Version 2.3.09. This web-based tool calculates both deterministic and probabilistic acceleration response spectra for any location in California based on criteria provided in Appendix B of Caltrans Seismic Design Criteria. The deterministic spectrum is determined as the average of median response spectra calculated using the Campbell-Bozorgnia (2008) and Chiou-Youngs (2008) GMPEs developed under the NGA project coordinated through the PEER-Lifelines program. These equations are applied to all faults considered to be active in the last 750,000 years (late-Quaternary age) that can produce a moment magnitude earthquake of 6.0 or greater. The probabilistic spectrum is obtained from the USGS (2008) National Hazard Map for 5% probability of exceedance in 50 years. Caltrans design spectrum is based on the larger of the deterministic and probabilistic spectral values. Both the deterministic and probabilistic spectra account for soil effects through incorporation of the parameter V_{s30} .

3.3.3 California Building Code 2016

The design response spectrum corresponding to the CBC 2016 was calculated using the online tool provided by the Structural Engineers Association of California (SEAOC) and California Office of Statewide Health Planning and Development (OSHPD). The calculations are based on ASCE/SEI 7-10 and assume Risk Category II structures. Site Class C was used based on the V_{s30_mean} presented above.

4. RECOMMENDED DESIGN RESPONSE SPECTRA

This section provides recommended response spectra for use in the ongoing planning process on the ITC Project. To facilitate the development of these recommended spectra, the Project alignment was divided in five segments, each surrounding a planned station along the Project alignment as identified in Figure 1. The response spectra provided should be considered applicable for both aerial guideway and ancillary structures within each segment under the base Project as well as for the elements of the Market Street Alternative.

As part of the development of recommended design response spectra for the Project, an evaluation was conducted of the relative seismic hazard and nature of site conditions in each segment based on available information. The objective of this evaluation was to assess whether it would be appropriate to develop a single set of design response spectra to conservatively represent hazards to each segment of the project. The use of a single, conservative spectra is appropriate for the purposes of this study. Based on these evaluations and due to the similarity of the site conditions (V_{s30_mean}) and seismic hazard over the entire footprint of the project, the development of a single set of spectra using coordinates in the central portion of the project as representative was judged appropriate.

The coordinates of the center of Segment 3 (labelled as Center of Segment 3 in Figure 1) were considered to be representative of the entire project area. The corresponding latitude and longitude are 33.959 degrees and -118.344 degrees, respectively. Figure 4 shows the results for the MSSDC (i.e., UCERF3/NGAWest2), Caltrans deterministic, Caltrans probabilistic, and CBC 2016 design spectra. These spectra are summarized in Table 2.

Note that there are three Caltrans deterministic spectra corresponding to the Newport Inglewood Fault (A), Compton Fault (B), and Puente Hills Fault (C). The MDE design response spectrum exceeds the Caltrans and CBC 2016 spectra.

This assessment of seismic hazard should be implemented in conjunction with the design approaches contained in Chapter 3, Part A of Supplementary Seismic Design Criteria (Metro, 2012) for Aerial Guideways and Bridges and the applicable section of CBC 2016 for ancillary structures.

5. LIMITATIONS

The conclusions, recommendations, and opinions made herein assume that subsurface conditions do not deviate appreciably from those found during the referenced previous investigations by others. This report has been prepared in accordance with current practices and the standard of care exercised by scientists and engineers performing similar tasks in this area. The conclusions contained in this report are based solely on the analysis of the conditions reviewed by Geosyntec personnel. We cannot make any assurances concerning the completeness of the data performed by others. This evaluation is not intended to replace site-specific geologic investigation in support of detailed engineering design for the Project.

No warranty, expressed or implied, is made regarding the professional opinions expressed in this report. If actual conditions are found to differ from those described in the report, or if new information regarding the site is obtained, Geosyntec should be notified and additional recommendations, if required, will be provided. Geosyntec is not liable for any use of the information contained in this report by persons other than Pacifica Services, Inc., or their subconsultants, or the use of information in this report for any purposes other than referenced in this report without the expressed, written consent of Geosyntec.

6. REFERENCES

- California Department of Mines and Geology (2006). *Seismic Hazard Zone Report for the Inglewood 7.5-Minute Quadrangle*, Los Angeles County, California, Seismic Hazard Zone Report 027, 2006 Revision, Department of Conservation, Division of Mines and Geology.
- California Geological Survey (2019). *MS48: Shear-wave Velocity in the Upper 30 m of Surficial Geology*, Source <http://spatialservices.conservation.ca.gov/arc>.
- Field, E. H., Biasi, G. P., Bird, P., Dawson, T. E., Felzer, K. R., Jackson, D. D., Johnson, K. M., Jordan, T. H., Madden, C., Michael, A. J., Milner, K. R., Page, M. T., Parsons, T., Powers, P. M., Shaw, B. E., Thatcher, W. R., Weldon, R. J., II, and Zeng, Y. (2013), “Uniform California earthquake rupture forecast, version 3 (UCERF3)—The time-independent model: U.S. Geological Survey Open-File Report 2013–1165,” 97 p., California Geological Survey Special Report 228, and Southern California Earthquake Center Publication 1792, <http://pubs.usgs.gov/of/2013/1165/>.
- Field, E. H., Jordan, T. H., and Cornell, C. A. (2003), “OpenSHA: A Developing Community-Modeling Environment for Seismic Hazard Analysis,” *Seismological Research Letters*, 74(4), 406-419.
- Kamai, R., and Abrahamson, N. (2015), “Are Near-Fault Fling Effects Captured in the New NGA West2 Ground Motion Models?,” *Earthquake Spectra*, Pre-print accessed on February 20, 2015.

TABLES

Table 1: Summary of Seismic Design Criteria





		Design Criteria	
		Operating Design Earthquake (ODE)	Maximum Design Earthquake (MDE)
<u>Design Objective</u>		“Structures should be designed to respond without significant structural damage, the low level of damage that may occur shall be repairable during normal operating hours.”	“Structures should be designed to survive the deformation imposed, avoid major failure, and maintain life safety. The objective is to provide adequate strength and ductility to prevent collapse of the structure. The extent of the structure damage should be limited to what is visible and repairable.”
<u>Project Elements</u>	<u>Aerial Guideways and Bridges</u>	144-year return period event	2,475-year return period event, compare to Caltrans seismic design criteria and apply the more critical design load.
	<u>Ancillary Surface Facilities</u>	144-year return period event	2,475-year return period event, compare to the applicable CBC 2016 loading and apply the more critical design load.

Table 2: Summary of Recommended Response Spectra

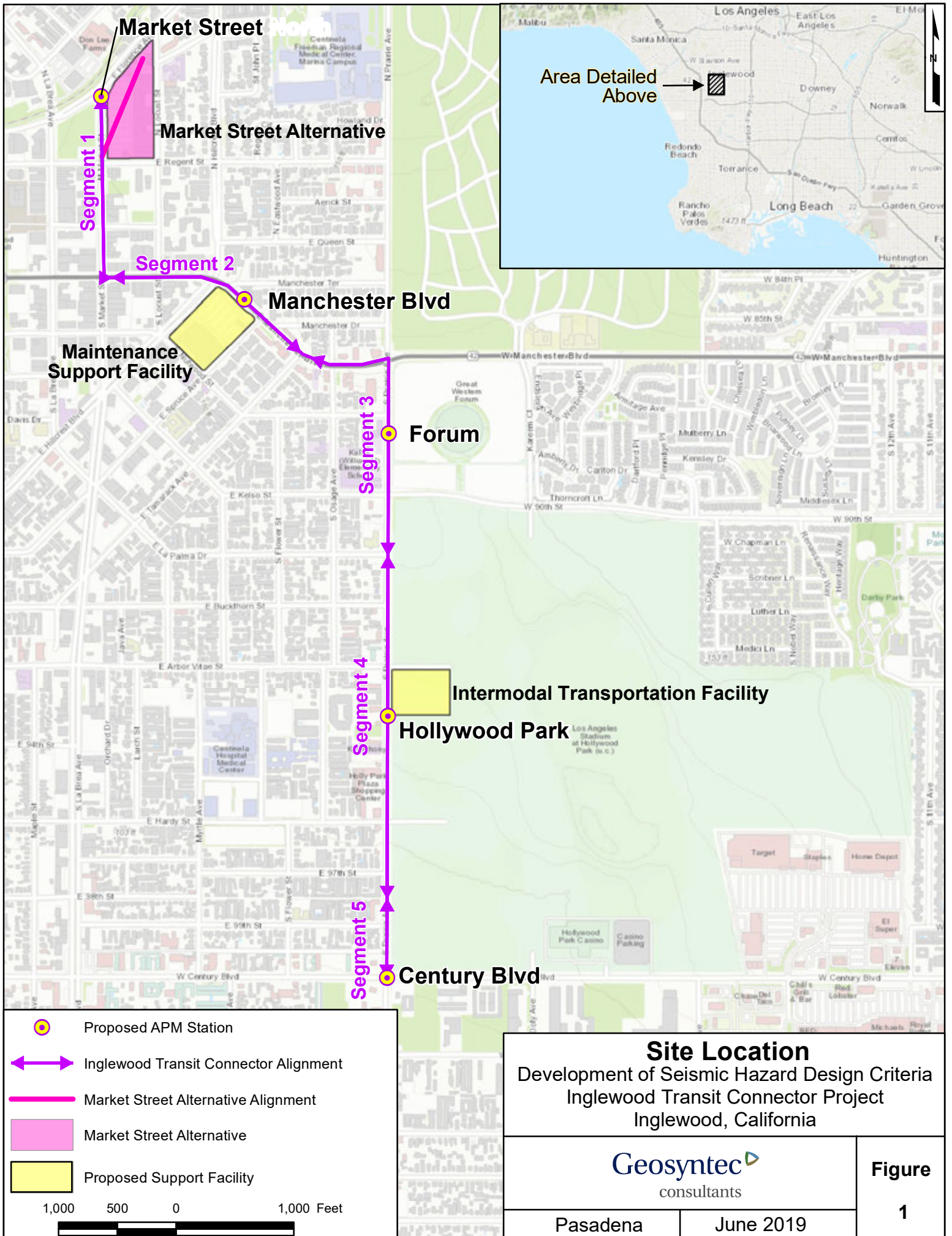
Spectrum	Spectral Acceleration at Identified Period (g)									
	0.01 (PGA)	0.1	0.2	0.3	0.5	1.0	2.0	3.0	4.0	5.0
ODE	0.31	0.61	0.76	0.72	0.55	0.29	0.13	0.08	0.06	0.04
MDE	0.95	1.78	2.67	2.39	2.02	1.23	0.56	0.35	0.24	0.18
Caltrans Deterministic A	0.55	0.89	1.14	1.18	1.14	0.96	0.49	0.30	0.21	0.16
Caltrans Deterministic B	0.53	0.93	1.16	1.11	0.96	0.67	0.25	0.12	0.07	0.06
Caltrans Deterministic C	0.42	0.73	0.92	0.89	0.78	0.57	0.23	0.13	0.09	0.07
Caltrans Probabilistic (5%/50 years)	0.56	1.05	1.23	1.23	1.05	0.79	0.39	0.24	0.17	0.14
CBC 2016	0.54	1.17	1.17	1.17	1.11	0.56	0.28	0.19	0.14	0.11

FIGURES



-  Proposed APM Station
-  Inglewood Transit Connector Alignment
-  Market Street Alternative Alignment
-  Market Street Alternative
-  Proposed Support Facility

1,000 500 0 1,000 Feet



Site Location
 Development of Seismic Hazard Design Criteria
 Inglewood Transit Connector Project
 Inglewood, California

Geosyntec
 consultants

Pasadena	June 2019	Figure 1
----------	-----------	-------------------------------

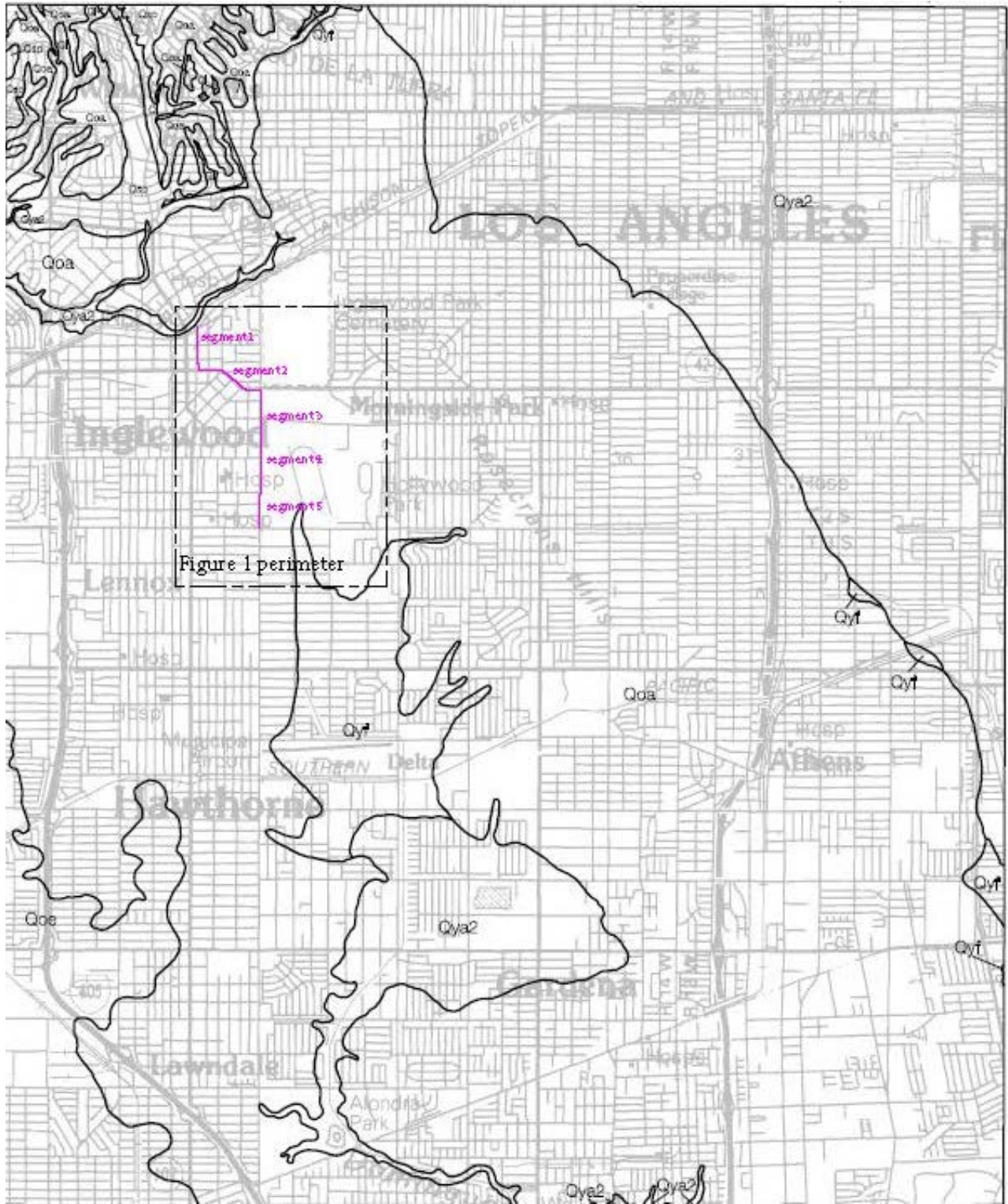

Inglewood Quad Geologic Map (CDMG, 2016)
Development of Seismic Hazard
Design Criteria
Inglewood Transit Connector Project

Geosyntec
consultants

Figure

2

HPA1043

June 2019

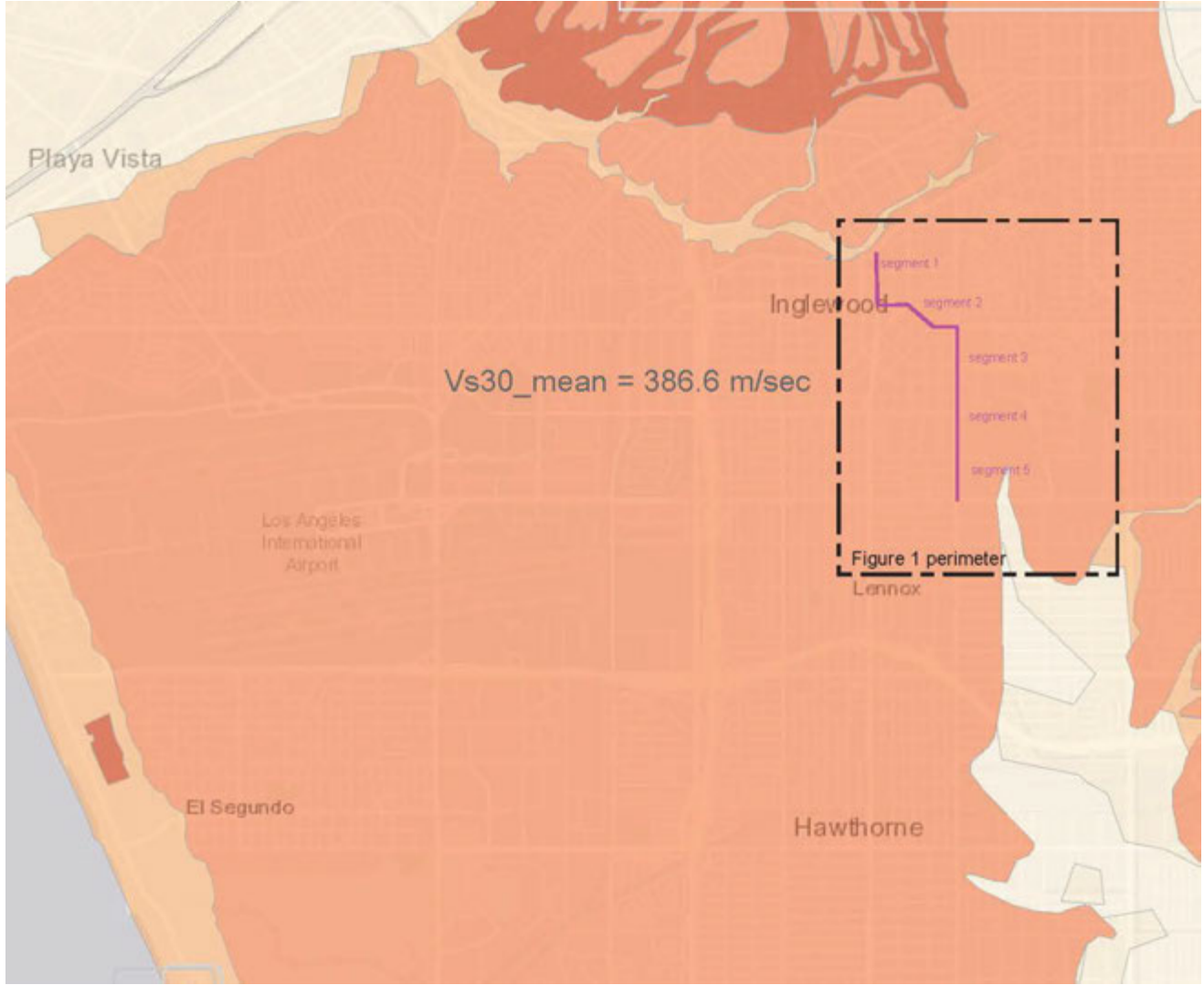

Mean Vs30 (from CGS, 2019) Development of Seismic Hazard Design Criteria Inglewood Transit Connector Project		Figure 3
		
HPA1043	June 2019	

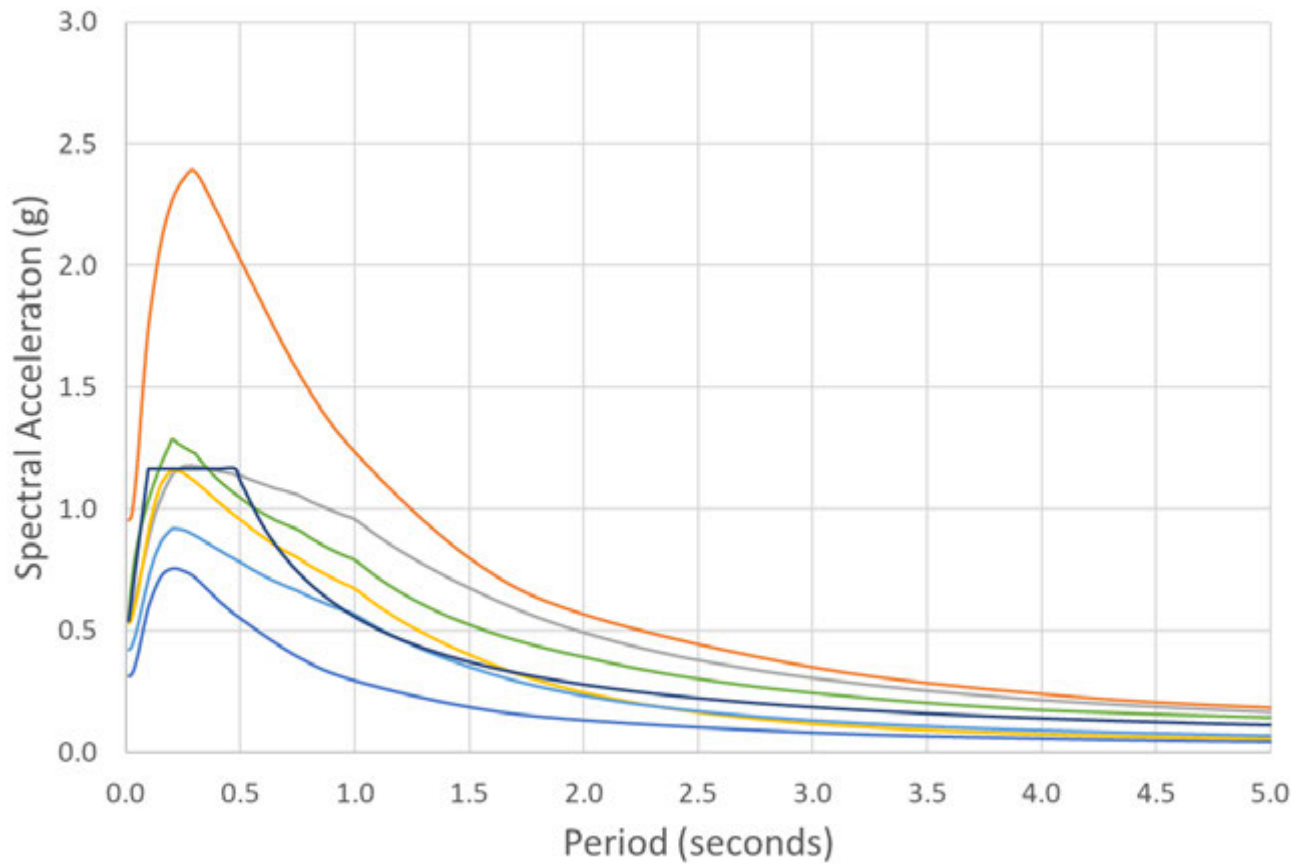

- ODE: UCERF3/NGAWest2
- MDE: UCERF3/NGAWest2
- Caltrans: Deterministic A
- Caltrans: Deterministic B
- Caltrans: Deterministic C
- Caltrans: Probabilistic (5%/50yrs)
- CBC 2016

Design Response Spectra Development of Seismic Hazard Design Criteria Inglewood Transit Connector Project	
HPA1043	June 2019

APPENDIX A

**METRO SUPPLEMENTAL SEISMIC DESIGN
CRITERIA**

APPENDIX A
METRO SUPPLEMENTAL SEISMIC DESIGN CRITERIA

METRO SUPPLEMENTAL SEISMIC DESIGN CRITERIA TABLE OF CONTENTS

CHAPTER 1 INTRODUCTION

- 1 Introduction
- 1.1 Background
- 1.2 Two Level Approach to Seismic Design
- 1.3 Design Policies and Objectives
- 1.4 The LRFD Philosophy

Chapter 1 References

CHAPTER 2 SEISMIC DESIGN GROUND MOTION CRITERIA

- 2.1 General
- 2.2 Geologic and Seismic Environment
- 2.3 Probabilistic Seismic Ground Motion Criteria
- 2.4 Surface Fault Rupture Displacement

Tables

- 2-1 Geologic Units Associated with Existing or Proposed Tunnel Alignments

Figures

- 2-1 Location Map of Los Angeles County Showing Physiographic Provinces, Selected Faults and Significant Earthquakes
- 2-2 Seismicity Map
- 2-3 Significant Earthquakes in the Los Angeles Area
- 2-4 Steps in Probabilistic Seismic Hazard Analysis
- 2-5 Example of Acceleration Special Matching
- 2-6 Example Shoring ODE and MDE Spectra at a Bridge Site
- 2-7 Types of Earthquake Faults
- 2-8 Relationships between maximum Surface Fault Displacement and Earthquake Moment Magnitude for Strike-Slip Faulting

Chapter 2 References

CHAPTER 3 SUPPLEMENTARY SEISMIC DESIGN CRITERIA (SSDC)

Part A Metro SSDC for Aerial Guideways and Bridges

- 3A1.0 Scope
- 3A2.0 Design Policy
- 3A3.0 Performance Objectives
- 3A4.0 Codes and Standards
- 3A5.0 Design Response Spectra
- 3A6.0 Design Ground Motions
- 3A7.0 Methods of Analysis
- 3A8.0 Design Forces
- 3A9.0 Structural Design
- 3A10.0 Minimum Seat Width
- 3A11.0 Restrainers
- 3A12.0 Seismic Base Isolation

3A13.0 Seismic Design for Ground and Embankment Stability

Chapter 3 Part A References**Part B Metro SSDC for Underground Structures**

3B1.0	Scope
3B2.0	Design Policy
3B3.0	Performance Objectives
3B4.0	Codes, Standards, and References
3B5.0	Seismic Hazard and Design Ground Motion Parameters
3B6.0	General Design Procedure
3B7.0	Bored Circular Tunnels
3B8.0	Reinforced Concrete Box Structures
3B9.0	Vertical Shaft Structures
3B10.0	Lateral Loading from New or Existing Buildings
3B11.0	Retaining Walls and U-Sections
3B12.0	Effects of Fault Rupture
3B13.0	Effects of Ground Instability

Figures

3B-1	Tunnel Transverse Ovaling and Racking Response to Vertically Propagating Shear Waves
3B-2	Tunnel Longitudinal Axial and Curvature Response to Traveling Waves
3B-3	Seismic Ovaling Coefficient K_1
3B-4	Lining Response Coefficient K_2 , for Poisson's Ratio=0.2
3B-5	Lining Response Coefficient K_2 , for Poisson's Ratio=0.35
3B-6	Lining Response Coefficient K_2 , for Poisson's Ratio=0.5
3B-7	Example of Two-Dimensional Continuum Finite Element Model
3B-8	Free-Field Soil Shear Displacement Profile and Racking Deformation of a Box Structure
3B-9	Racking Ratio Coefficient R_r for Rectangular Box Structures
3B-10	Simplified Racking Frame Analysis of a Rectangular Box Structure
3B-11	Sample Dynamic Time History Analysis Model
3B-12	Structure Mechanisms under MDE
3B-13	Tunnel-Ground Interaction Model at Fault Crossing
3B-14	Analytical Model of Ground Restraint for Tunnel at Fault Crossing

Chapter 3 Part B References

CHAPTER 1 INTRODUCTION

1 Introduction

This Seismic Design Criteria Revision updates the latest documents prepared in 2003 for Metro Gold Line Eastside Extension, and is compatible with the revision to the Metro Design Criteria Section 5 references to seismic design of structures, and provides an update to Section 5 Appendix Chapter 3 Part A for Aerial Guideways and Bridges, and the addition of Chapter 3 Part B for Underground Structures.

1.1 Background

In 1981, Southern California Rapid Transit District (SCRTD), the agency responsible for the design and construction of the Metro Rail project in Los Angeles retained Converse Consultants, the general geotechnical consultant and study team of special geotechnical experts to develop reasonable seismic design criteria for the proposed 18 mile segment of the project.

In May 1983, a report titled “Seismological Investigations & Design Criteria” was published. Part I of the report included a comprehensive review and evaluation of available geologic and seismologic information, determination of probable ground motion along the proposed route, estimation of representative 100 year probable and maximum credible ground motions and response spectra for the project. Part II of that report provides guidance and criteria to be used for seismic design. Appendix A, Part II of that report provides general discussion on the seismic design approach and philosophy, defines seismic classes, and details for the structural design. Appendix B of that report is titled “Commentary” and contains an expanded discussion of items covered in Appendix A.

In June 1984, Metro Rail Transit Consultants, general consultant to SCRTD, published “Supplemental Criteria for Seismic Design of Underground Structures”. This document has provided structural seismic design criteria for underground structures on past Metro Rail projects. Those criteria provide step by step procedures and figures to determine earthquake imposed deformations (racking) within different geologic units for Operating Design Earthquake (ODE), and Maximum Design earthquake (MDE) and structure mechanisms for the acceptable conditions during MDE.

The above referenced reports show commendable research and scholarship, which made them the “state of the art” for the seismic criteria for underground structures. The major principles espoused in these reports stood the test of the time and are used elsewhere around the world.

After the 1989 Whittier Narrows Earthquake and 1994 Northridge Earthquake, Engineering Management Consultants, general consultant to MTA, retained Woodward Clyde Consultants to prepare: 1) complete Probabilistic Seismic Hazard Analysis (PSHA) for each of the four planned Eastside stations and 2) develop representative response spectra based on PSHA results, for the Eastside Extension (The underground alignment which was subsequently abandoned). Woodward Clyde Consultants

recommended adopting racking and horizontal and vertical accelerations for ODE and MDE rather than using the figures from the earlier supplemental criteria. The recommendation to change the seismic criteria for underground stations was implemented by MTA in 1997.

In the preparation of the design-build performance specifications for the Metro Gold Line Eastside Extension produced Section 01152.05, Appendix A, Structural/Geotechnical Supplemental Criteria for Design of Aerial Structures and Bridges, and Appendix B, Structural/Geotechnical Underground structures. Updating the Metro Design Criteria Section 5 references to seismic design of structures, Section 5 Supplement A for aerial structures, and the addition of Supplement B for Underground structure are the current revisions described in the Metro Supplemental Seismic Design Criteria documented by this Report.

1.2 Two Level Approach to Seismic Design

The choice of the design ground motion level, whether based upon probabilistic or deterministic analysis, cannot be considered separately from the level of performance specified for the design event. Oftentimes, important facilities are designed for multiple performance levels (e.g., with a different ground motion level assigned to each performance level, a practice referred to as performance based design. Common performance levels used in design of transportation facilities include protection of life safety and maintenance of function after the event. A safety level design earthquake criteria (a “rare” earthquake) is routinely employed in seismic design. Keeping a facility functional after a more frequent earthquake adds another requirement to that of simply maintaining life safety, and is typically only required for important facilities.

Current AASHTO LRFD Design Specifications and Guide Specifications has no explicit requirements for checking bridge performance for more frequently occurring ground motions than those that occur every thousand years, on average. But many owners want to be assured that certain important bridges will be functional in frequently occurring earthquakes such as those with return periods of the order of a hundred years or so.

Since Metro Rail is a very important transit facility that requires substantial financial investment and has significant economic consequences if it fails, a two-level ground motion approach to seismic design similar to that outlined in Applied Technology Council/Multidisciplinary Center for Earthquake Engineering Research, 2003, *Recommended LRFD Guidelines for the Seismic Design of Highway Bridges* (ATC-49) is appropriate. The Maximum Design earthquake (MDE) and the Operating Design Earthquake (ODE) discussed below form the basis of the two-level ground motion approach adopted for the Metro Rail project.

The Maximum Design earthquake (MDE): The collapse or significant disruption of the Metro Rail system during or after a major seismic event could have catastrophic effects not only on the Metro Rail system itself but also on many other aspects including the potential disturbance to other surface structures above the collapsed underground tunnel structures and the direct and indirect business and social losses. Furthermore, the repair to or replacement of an underground structure (which forms a major portion of the Metro Rail system) is considerably more difficult and costly than that for surface structures such as buildings. Modern buildings are being designed to withstand seismic

ground motions with a return period of approximately 2,500 years. The risk for the Metro Rail structure collapse needs to be at least no greater than that for the buildings. Many recent transit and important transportation facilities have also adopted the 2,500-year criteria for the safety level ground motions, including the Seattle Sound Transit Bridges and Tunnels, the Seattle Alaskan Way Tunnels, the New York City Transit Bridge and Tunnels, and the New Jersey Transit (Bridges and Tunnels). Therefore the Metro Rail structures need to be designed to sustain seismic ground motions based on the 2,500-year criteria (i.e., 4% exceedance in 100 years). The Metro Rail structures should meet the life safety performance level (no collapse) discussed above. The service level would allow disruption to general traffic, but some limited access for light emergency vehicles should be available. Given the difficulty with abandoning or replacing a transit facility of this size and nature, a repairable damage level should be considered in lieu of “significant damage” sometimes used for other projects.

Operating Design Earthquake (ODE): In practice, where a lower level (more frequently occurring) earthquake is chosen to check functionality, the selected return period has varied from project to project, even within the same geographic region. In the west coast (e.g., cities in California and Seattle), a return period typically in the range of 100 to 150 years have been used for various transit projects (e.g., 108 years for the Seattle Alaskan Way Tunnel, and 150 years for the Seattle Sound Transit and the SF Central Subway). The lower-level design earthquake selected used for these projects is one that is expected to occur during the service life of the facility, typically based on a 50% chance of exceedance in the life of the facility. Since the design service life of the Metro Rail is 100 years, the corresponding return period for a 50% chance of exceedance is about 150 year. Therefore for the lower level design earthquake (i.e., the ODE) a return period of 150 years (50% probability of exceedance in 100 years) is selected for the Metro Rail project. One of the primary purposes in designing for the lower-level ground motions is to reduce the likelihood of future repair and maintenance costs by minimizing damage during more frequently occurring earthquakes. The service level requirement under the ODE is for the facility to be put back in service for general traffic immediately after a post-earthquake inspection. This applies not only to the structure but also to the mechanical systems needed for safe tunnel operation. The damage service level is none to minimal.

The procedures to develop the MDE and ODE ground motion criteria for Aerial and Underground Structures are described in Chapter 2.

1.3 Design Policies and Objectives

The criteria and codes specified herein shall govern all matters pertaining to the design of Metro owned facilities including bridges, aerial guideways, cut-and-cover subway structures, tunnels, passenger stations, earth-retaining structures, surface buildings, miscellaneous structures such as culverts, sound walls, and equipment enclosures, and other non structural and operationally critical components and facilities supported on or inside Metro structures. These criteria also establish the design parameters for temporary structures. The minimum design life objective for permanent structures designed to meet this criteria shall be 100 years.

These seismic criteria also apply to existing adjacent buildings, their foundations, and their utility services not owned by Metro, but that fall into the zone of influence of Metro’s

temporary and permanent facilities being designed. Where cases of special designs are encountered that are not specifically covered by these criteria, the designer shall bring them to the attention of Metro to determine the technical source for the design criteria to be used.

1.3.1 Design Policy

Metro Rail projects are large-scale public projects in areas susceptible to major earthquakes. Earthquake initiated failures of associated structures and systems could lead to loss of life and/or major disruption of transportation systems.

The philosophy for earthquake design for these criteria is to provide a high level of assurance that the overall system will continue operating during and after an Operating Design Earthquake (ODE). Damage, if any, is expected to be minimal and to minimize the risk of derailment of a train on the bridge at the time of the ODE. Further, the system design will provide a high level of assurance that public safety will be maintained during and after a Maximum Design Earthquake (MDE).

1.3.2 Design Objectives

For the ODE, which may occur more than once during the normal 100 year life expectancy, the structure should be designed to respond without significant structural damage; the low level of damage that may occur shall be repairable during normal operating hours.

For the MDE, which has a low probability of being exceeded during the normal 100 year life expectancy, the structure should be designed to survive the deformation imposed, avoid major failure, and maintain life safety. The objective is to provide adequate strength and ductility to prevent collapse of the structure. The extent of the structural damage should be limited to what is visible and repairable.

Aerial Guideways and Bridges -- In the case of bridges and aerial guideways, the design shall not result in less seismic performance capability than that required by Caltrans. To substantiate that this necessity has been met, design check calculations using Caltrans criteria may be required. The foundations of bridge and aerial guideway associated structures shall be designed taking into account the effects of soil-structure interaction. The American Disabilities Act requirements between the vehicle floor and station platforms will be considered in the analysis of dead and live load deflections and camber growth. The full loads resulting from construction equipment and other temporary elements shall be applied unless otherwise allowed by Metro. Detailed Seismic Design Criteria are documented in Chapter 3, Part A.

Underground Guideway and Structures -- For the seismic design and analysis of underground tunnels and support spaces circular in section, the structures should be based primarily on the ground deformation as opposed to the inertial force approach. In cases where the underground structure is stiff relative to the surrounding ground, the effect of soil-structure interaction shall be taken into consideration. Other critical conditions requiring soil-structure interaction verification include the contiguous interface between flexible and rigid components or the interface of two different structures such as a tunnel and a station, a cross-passage or ventilation building, and a station and an

entrance, or a vent shaft. Detailed Seismic Design Criteria are documented in Chapter 3, Part B.

Ancillary Surface Facilities – Some ancillary facilities are subject to both the code forces normally applied to surface buildings as well as those being applied to the transit guideways. Whichever code applies the most critical set of requirements shall apply to the design.

1.3.3 Seismic Ground Motion Considerations

The methodology for development of seismic ground motion criteria for design of both Aerial and Underground Structures (reflecting both the ODE and MDE) is documented in Chapter 2. The criteria should be developed on a site specific basis and based on 2009 probabilistic seismic hazard analysis procedures documented by the USGS and Caltrans. The procedures incorporate the latest consensus on active fault magnitude and recurrence relationships in the Los Angeles region, and on recently developed ground motion attenuation relationships. Any departure from these procedures due to new developments must be approved by Metro. Design considerations related to fault displacement estimates are also addressed in Chapter 2.

1.4 The LRFD Philosophy

The Federal Highway Administration (FHWA) and the Nation's states have established a goal that LRFD standards be incorporated in all new designs after 2007. In addition, most non-highway codes and standards have already or are beginning to follow suit in a trend that is extremely unlikely to be reversed. The Seismic Design Criteria documented in Chapter 3 have adopted the LRFD Philosophy.

Working stress design (WSD) began to be adjusted in the early 1970s to reflect the variable predictability of certain load types, such as wind loads, through adjusting design factors. This design philosophy is referred to as load factor design (LFD). A further philosophical extension results from considering the variability in the properties of structural elements, in similar fashion to load variabilities. While considered to a limited extent in LFD, the design philosophy of load-and-resistance factor design (LRFD) takes variability in the behavior of structural elements into account in an explicit manner. LRFD relies on extensive use of statistical methods, but sets forth the results in a manner readily usable by bridge and aerial guideway designers and analysts.

Applying the concepts of LRFD leads to an AASHTO specified design life of 75 years. Design Life as used here means the period of time on which the statistical derivation of transient loads is based. With the additional seismic and other precautions taken with the aerial structures, and the mainly static forces applied to underground structures, the service life for structures carrying rail transit as designed under these criteria is 100 years.

LRFD employs specified Limit States to achieve the objectives of constructability, safety, and serviceability. A Limit State is defined as a condition beyond which a structure or structural component ceases to satisfy the provisions for which it was designed. The resistance of components and connections are determined, in many cases, on the basis of inelastic behavior, although the force effects are determined by using elastic analysis.

This inconsistency is common to most current specifications as a result of incomplete knowledge of inelastic structural action.

LRFD uses extreme event limit states to ensure the structural survival of structures during a major earthquake or flood, or when there is a potential collision by rail or rubber tired vehicles. Extreme Event Limit States are considered to be unique occurrences whose return period may be significantly greater than the design life of the bridge.

LRFD also classifies structures on the basis of operational importance. Such classification is based on the social-survival-and/or security-defense requirements. Metro is responsible for declaring a structure or structural component to be operationally important.

REFERENCES

1. State of California Department of Transportation (Caltrans) Bridge Design Specification (BDS) referenced "LRFD Bridge Design Specifications", Fourth Edition, 2007, (Including 2008 and 2009 Interims), by the American Association of State Highway and Transportation Officials, (AASHTO).
2. American Association of State Highway and Transportation Officials, (AASHTO-CRV), "Guide Specifications for Horizontally Curved Steel Girder Highway Bridges," 2003.
3. Allen, T.M., "Development of Geotechnical Resistance Factors and Downdrag Load Factors for LRFD Foundation Strength Limit State Design, Publication No. FHWA-NHI-05-052. Federal Highway Administration, 2005.
4. Allen, T.M., A. Nowak, and R. Bathurst, "Calibration to Determine Load and Resistance Factors for Geotechnical and Structural Design," TRB Circular E-C079, Transportation Research Board, Washington DC, 2005.
5. California Building Standards Commission, "California Building Code, California Code of Regulations, Title 24," based on the 2006 International Building Code, 2007.
6. US Department of Transportation, Federal Highway Administration, National Highway Institute, "Technical Manual for Design and Construction of Road Tunnels – Civil Elements", March 2009 (FHWA-NHI-09-010), 2010.

CHAPTER 2

SEISMIC DESIGN GROUND MOTION CRITERIA

2.1 General

This Chapter describes the current Metro Seismic Design Ground Motion Criteria to be used for Aerial Guideways and Structures Chapter 3, Part A and for Underground Guideways and Structures Chapter 3, Part B. The Ground Motion Criteria replaces previous criteria used by Metro for projects as described in:

1. The “Supplemental Criteria for Seismic Design of Underground Structures” published in June 1984 by Metro Rail Transit Consultants.
2. The Section 5 Structural Supplement A “Ground Motion Response Spectra for Bridge and Elevated Structures Proposed Metro Rail Projects, Los Angeles County, California” prepared by Law/Crandall Inc, in 1994.
3. The 1997 Ground Motion Criteria developed for four stations for the Eastside Extension, prepared by Woodward Clyde Consultants.
4. The Structural/Geotechnical ground motion criteria prepared for Aerial Underground Structures (Appendices A and B) for the Eastside Extension design-build specifications.

Section 2.2 provides an overview of the Geologic and Seismic Environment related to existing or proposed Metro transportation alignments including descriptions of the regional stratigraphy, tectonics, historical seismicity, and principal active faults.

Section 2.3 describes the use of probabilistic seismic hazard analyses for the development of the site specific Operating Design Earthquake (ODE) and Maximum Design Earthquake (MDE) ground motion criteria for aerial and underground structures. Criteria development includes:

1. Determination of ground surface design spectra, and peak ground motion parameters for aerial structures.
2. Determination of design spectra at depths below underground structures for development of matching acceleration time histories.
3. Procedures for determining spectral matched acceleration time histories for analyses.

Section 2.4 discusses the evaluation of fault rupture potential and methods used to determine fault rupture characteristics and displacement estimates. Probabilistic methods for estimating fault displacements are also noted.

2.2 Geologic and Seismic Environment

2.2.1 Regional Stratigraphy

The existing and proposed Metro Transportation alignments traverse portions of four major physiographic features as shown in Figure 2-1, namely the Los Angeles Basin, the Santa Monica Mountains, the San Gabriel Valley, and the San Fernando Valley. The Los Angeles Basin, once a marine embayment, accumulated sediments eroded from surrounding highlands during the Miocene and Pleistocene epochs beginning about 25 million and one million years ago, respectively. Uplift of the Santa Monica Mountains provided much of the sediment filling the Basin. Volcanic activity also produced extensive accumulations of basalt in the Santa Monica Mountains during the Miocene epoch. The Los Angeles Basin and the San Fernando Valley were uplifted during the Pleistocene epoch. Rapid uplift and erosion was in early Pleistocene time, filling the Los Angeles Basin with about 1,300 feet of sandy sediments (San Pedro Formation). Holocene time (beginning with the last melting of the Ice Sheets 11,000 years ago) resulted in alluvium (coarse gravels and sands) being deposited in stream channels extending into the Los Angeles Basin. The San Fernando Valley has been filled with considerably thicker deposits of alluvial sediments than the northern part of the Los Angeles basin.

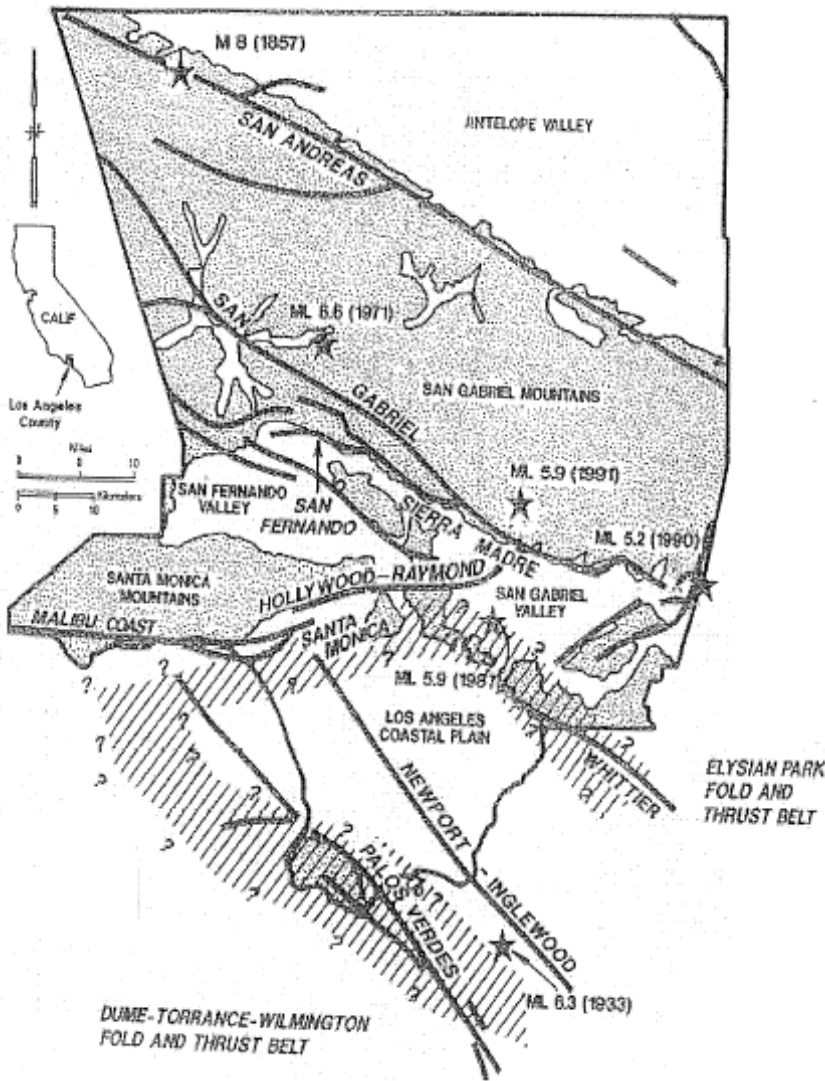

Figure 2-1 Location map of Los Angeles County showing physiographic provinces, selected faults and significant historic earthquakes. Fold and thrust belts shown from Hauksson (1990) represent potentially significant “blind” seismogenic sources. (After Gath, 1992)

Geologic units associated with existing or proposed tunnel alignments in order of increasing age, are shown in Table 2-1. With reference to this table, the geologic materials ranging from Alluvium through the Puente Formation can be regarded as being associated with soft ground or soft rock tunneling methods. The harder rock formations associated with the Topanga Formations and the granitic rocks encountered in the Santa Monica Mountains, require hard rock tunneling techniques.

**Table 2-1 – Geologic Units Associated with Existing or Proposed Tunnel Alignments
(after Converse et al. 1981)**

Formation	Map Symbol	Description
Young Alluvium	(Qal)	Silt, sand, gravel, and boulders; chiefly unconsolidated (loose) and granular.
Old Alluvium	(Qalo)	Clay, silt, sand, and gravel; chiefly consolidated (stiff) and fine-grained.
San Pedro Formation	(Sp)	Sand; clean, relatively cohesionless; locally impregnated with oil or tar (Formation not exposed at surface on Geologic map).
Fernando Formation	(Tf)	Claystone, siltstone, sandstone; chiefly soft, stratified siltstone; local hard sandstone beds.
Puente Formation	(Tp)	Claystone, siltstone, sandstone; chiefly soft, stratified siltstone; local hard sandstone.
Topanga Formation	(Tt)	Siltstone, sandstone, conglomerate; chiefly hard, well cemented, massive sandstone; local soft, thin siltstone beds; includes some Cretaceous conglomerate and sandstone, undifferentiated beds.
Topanga Formation	(Tb)	Basalt; includes dolerite and andesitic basalt; non-columnar flows and intrusives; deeply weathered, soft crumbly at surface; hard, unweathered at depth.
Alluvial Fan	(Qf)	Silt, sand, gravel, and boulders; primarily semi-unconsolidated (dense) and granular.
Modelo Formation	(Tm)	Claystone, siltstone, sandstone; chiefly soft, diatomaceous stratified siltstone; local hard sandstone beds.
Granite	(Cg)	Chiefly granodiorites; deeply weathered, soft at surface; hard unweathered at depth.

The floor of the Basins are underlain by Quaternary-age sandy sediments with local silts, clays, and gravels. These generally can be subdivided into non-indurated loose Holocene-age sediments, and non-indurated, but denser, Pleistocene-age materials.

The uppermost Pleistocene materials are generally non marine deposits referred to as the Lakewood Formation which is on the order of 125,000 to 500,000 years old (California Department of Water Resources, 1961). These late- to middle-Pleistocene sediments overlie older, early-Pleistocene, marine sediments referred to as the San Pedro Formation which is more than 500,000 years old. The San Pedro Formation overlies marine Tertiary-age (> 2 million years) sediments and sedimentary rocks. These include the Pico, Repetto, Fernando, Puente, and Monterey formations. The Tertiary-age sediments and rocks, in turn, overlie Mesozoic-age (~100 million years) crystalline basement rocks at depths ranging from about 1,500 to 3,000 m west of the Newport-Inglewood Structural Zone (NISZ) to as much as 10,000 m in the deepest part of the central basin east of the NISZ (Yerkes et al., 1965). The basement west of the NISZ is

primarily metamorphic rock (schist) whereas the basement to the east includes both metamorphic and igneous rocks.

2.2.2 Regional Tectonics

Except for the Newport-Inglewood Structural Zone, most surface geological faults such as the Santa Monica, Hollywood, and Whittier faults occur along the Basin margins. In addition to these known surface faults, the Los Angeles region is underlain by subsurface thrust and reverse faults (commonly referred to as "blind" faults and shown approximately on Figure 2-1 as dashed lines). These are poorly understood features with poorly known locations and orientations. Most of the known subsurface faults underlie the higher-standing plains along the inland margin of the Basin, but others have been proposed (for example, the San Joaquin Hills thrust fault). Most large earthquakes associated with these subsurface features are most likely to originate at depths between 10 and 15 km. The 1987 Whittier earthquake occurred on one of these buried faults that dips northerly under the Repetto Hills and San Gabriel Basin.

The present tectonic regime appears to have been in place since middle Pleistocene time and the present-day configuration of the Los Angeles Basin would have been recognizable about 200,000 to 300,000 years ago. The greatest tectonic activity within late Pleistocene time has occurred primarily in proximity to the major surface faults such as the Palos Verdes, Malibu-Santa Monica-Hollywood, Newport-Inglewood, Whittier, and Sierra Madre faults. The subsurface thrust faults within the region have not been active enough to create similar prominent uplifts and only a few (e.g. Santa Fe Springs) even have subtle recognizable surface expression.

2.2.3 Regional Seismicity

The southern California area is seismically active as shown on the seismicity map of Figure 2-2. Additional seismicity information is provided in Figure 2-3, which shows some of the more notable earthquakes in the Los Angeles Basin. Seismicity in the Los Angeles Basin does not clearly correlate to surface faults. There is no concentration or clustering of earthquakes in the site region except perhaps along the NISZ where a series of aftershocks from the 1933 event are located. Ward (1994) suggested that as much as 40% of the tectonic strain in southern California is not released on known faults. Part of this difficulty is due to the fact that the Basin is underlain by the several poorly known blind thrust faults as noted above.

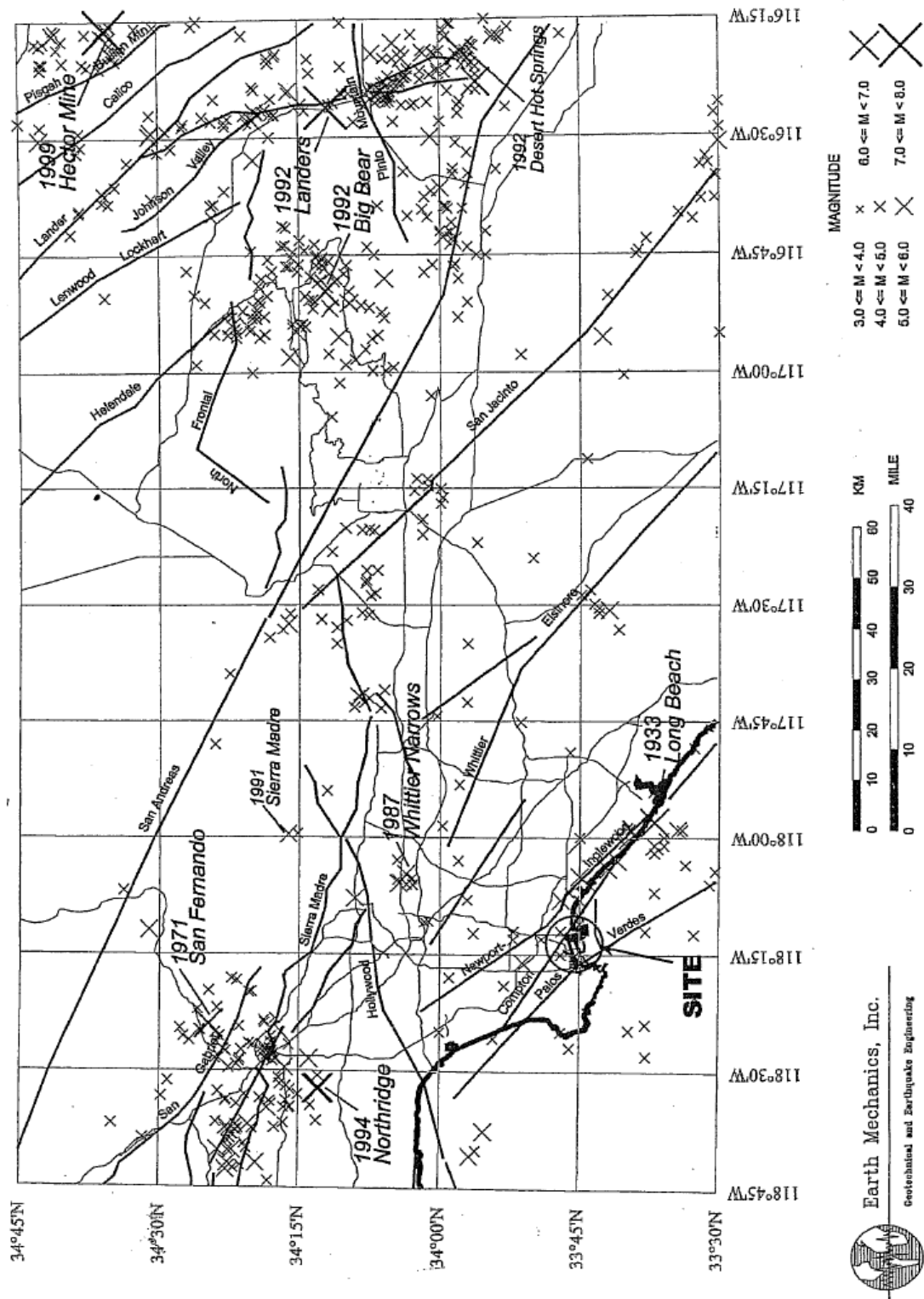
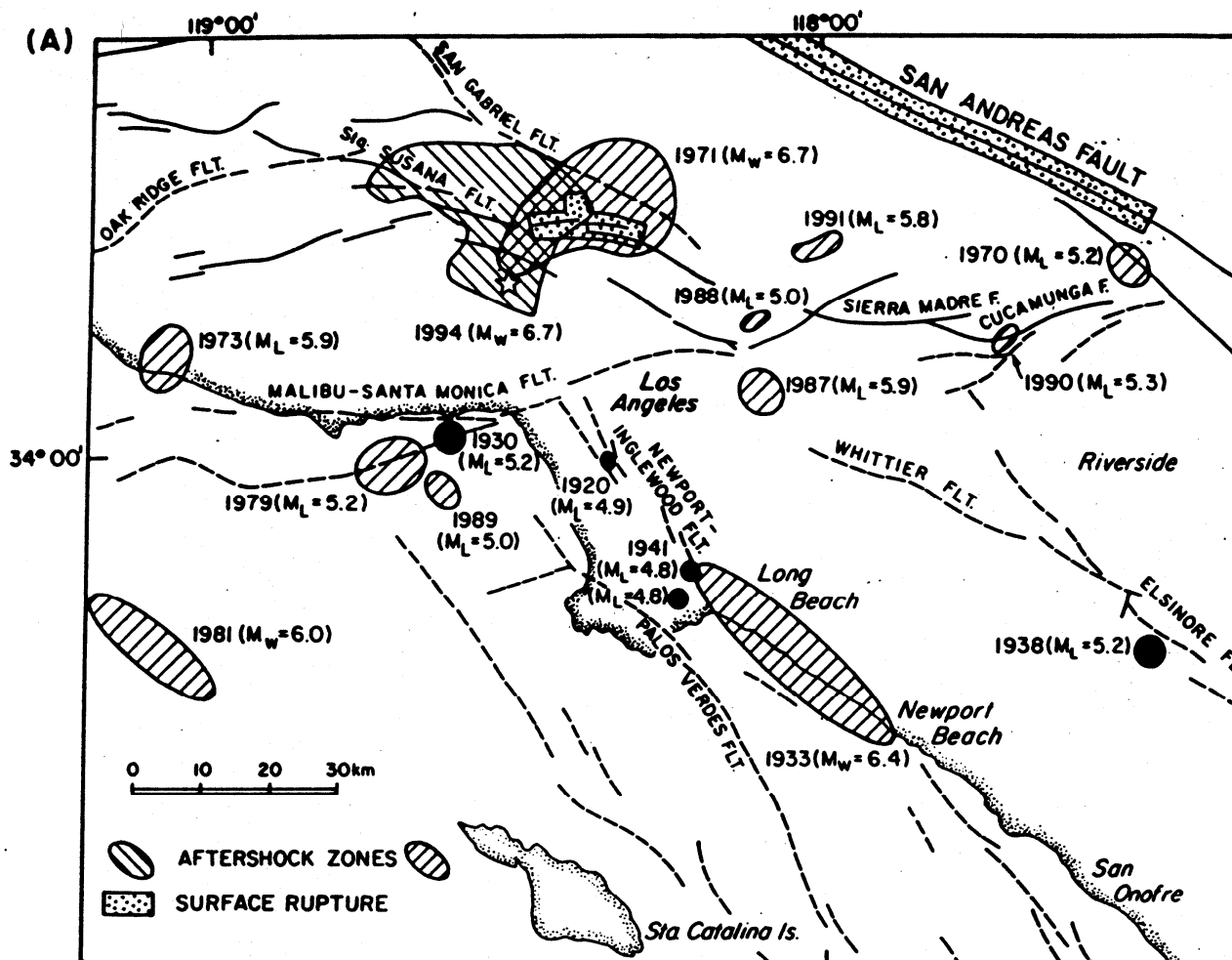

Figure 2-2 Seismicity Map



Note: Cross-hatched areas indicate aftershock zones (after Hauksson, 1995)

Figure 2-3 Significant Earthquakes in the Los Angeles Area

The largest historical earthquake within the Los Angeles Basin was the 1933 Long Beach earthquake of $M_W = 6.4$ ($M_L = 6.3$). The 1971 San Fernando ($M_L = 6.4$, $M_W = 6.7$) earthquake occurred outside of the basin along the northern margin of the San Fernando Valley within a zone of mapped surface faults of the Sierra Madre fault zone. The more-recent 1987 Whittier earthquake ($M_L = 5.9$, $M_W = 5.9$) and the 1994 Northridge ($M_L = 6.4$, $M_W = 6.7$) earthquakes occurred under the San Gabriel Valley and the San Fernando Valley, respectively, but were not associated with surface faults. In the offshore region, there have been no major earthquakes ($M \sim 7.0+$) in historical times.

The 1933 Long Beach earthquake is generally believed to have been associated with the Newport-Inglewood Structural Zone (Benioff, 1938). This association was based on abundant ground failures along the trend but no unequivocal surface rupture was identified. Hauksson and Gross (1991) reevaluated the seismicity and relocated the 1933 earthquake to a depth of about 10 km below the Huntington Beach-Newport Beach city boundary.

Hauksson (1987, 1990) analyzed the historical seismicity of the Los Angeles Basin. Although several older events were included, the principal time frame of the earthquake record studied was from 1977 to 1989, only about 12 years. This is a short time relative to the geologic time scales that control crustal tectonic activity, and thus the results of the study must be used cautiously. Also, there were few moderate and no large events in this record. History has shown repeatedly that small earthquakes are not necessarily indicative of where larger events will occur and/or of the nature of the principal tectonic regime. Of 244 earthquake focal mechanisms, 59% were predominantly strike-slip, 32% were reverse, and the rest were normal-fault mechanisms. All of the events were widely distributed and intermixed, and patterns are ambiguous. A large proportion of the strike-slip events occurred along the NISZ but the distribution is generally loosely scattered. More of the reverse mechanisms occurred north of the latitude of Palos Verdes Hills than to the south but like the strike-slip events the pattern is loose and typified by widely scattered events. Most of the normal-fault mechanisms occurred in the offshore area, but several also occur along the NISZ.

In overview, both the earthquakes and the geologic structures in the Los Angeles Basin appear to characterize tectonic environments whereby the northernmost part of the Basin, adjacent to and including the Santa Monica Mountains, is primarily a contractional tectonic regime (thrust and reverse faulting); the middle part of the Basin (to about a line connecting the north side of the Palos Verdes Hills-Signal Hill-Peralta Hills is a mixture of contractional and transcurrent (transpressional) structures, and the southern part of the Basin is primarily a transcurrent regime (strike-slip faulting).

Without a history of repeated large earthquakes within the basin, it is difficult to characterize the maximum earthquake potential. Neither the 1971 San Fernando, the 1987 Whittier, nor the 1994 Northridge earthquakes occurred within the Los Angeles Basin. However, they occurred within the same basic compressional tectonic regime and thus are probably representative of the size of earthquakes likely to occur on the larger subsurface reverse faults within the basin. The maximum earthquakes for the strike-slip faults can be estimated only from comparison of empirical fault-length/earthquake-magnitude data, and these suggest events in the $M = 7$ to 7.25 range.

2.2.4 Principal Active Faults

The following paragraphs briefly describe the principal active faults in the Los Angeles region that potentially could impact Metro structures. Locations of these faults are shown on Figure 2-1. This information is given from a regional perspective for understanding the nature of the faults, and provides a basis for the parameters used in probabilistic seismic hazard analysis discussed in Paragraph 2-3. More detailed descriptions of active faults in the Los Angeles Region may be found in publications by Schell and Dolan et al.

Palos Verdes Fault

The Palos Verdes fault extends from the northeast side of the Palos Verdes Peninsula southeasterly into deep water of the Continental Borderland. Northwesternly, the fault extends into Santa Monica Bay. Together, these segments extend for a total length of about 100 km.

The Palos Verdes fault is predominantly a strike-slip fault but has a small vertical component (~10% to 15%). The slip rate of the Palos Verdes fault is based primarily on the geophysical and geological studies in the outer harbor of the Port of Los Angeles by McNeilan et al. (1996). McNeilan et al. estimated a long-term horizontal slip rate of between 2.0 and 3.5 mm/yr. A slip rate of 3.0 mm/yr (± 1 mm) is the rate used by the California Geological Survey and the U.S. Geological Survey.

There have been no significant earthquakes on the fault since arrival of the Franciscan missionaries in the 1700s so there are virtually no direct data to help constrain the recurrence interval for large earthquakes on the Palos Verdes fault. Using the empirical data of Wells and Coppersmith (1994) to indirectly make judgments on how long it would take to store up enough strain to generate a M6.8 to 7.4 earthquake, it appears that recurrence intervals for such earthquakes on the Palos Verdes fault would range from a few hundred to a few thousand years. For example, fault rupture scenarios evaluated by McNeilan et al. (1996) ranged from 180 to 630 years for a M6.8 event, 400 to 440 years for a M7.1 event, 1,000-1,100 years for a M7.2 event, and 830 to 1,820 years for a M7.4 event).

Newport-Inglewood Structural Zone

The Newport-Inglewood Structural Zone (NISZ) consists of the northwest-southeast trending series of faults and folds associated with an alignment of hills in the western Los Angeles Basin extending from the Baldwin Hills on the north to Newport Mesa on the south (Figure 2-1). The fault seems to have originated in late Miocene time but based on relative stratigraphic thickness of bedding across the zone, the greatest activity seems to have occurred since Pliocene time indicating the fault is quite young.

The NISZ comprises several individual faults and branch faults, few of which have good surface expression as actual fault scarps.

The maximum earthquake used for the NISZ in local geotechnical investigations has generally been magnitude 7.0. This may be relatively small for a feature as long as the SMB zone but the magnitude is based on the concept that the zone consists of shorter discontinuous faults, or segments, that behave independently. The fault was the source of the 1993 Long Beach earthquake of magnitude 6.3, but as with the Palos Verdes fault, the history of earthquakes on the NISZ is incomplete so it is difficult to estimate a maximum earthquake. Empirical fault-length/ earthquake-magnitude relations (Wells and Coppersmith, 1994) suggest an MCE of about 7.0.

The recurrence interval for the maximum earthquake on the NISZ is very long, on the order of a thousand years or more (Schell, 1991; Freeman et al., 1992; Shlemon et al., 1995; Grant et al., 1997). The rate of fault slip is poorly known but seems to be very slow.

Sierra Madre Fault

The Sierra Madre fault is one of the major faults in the Los Angeles region and lies along the southern margin of the San Gabriel Mountains forming one of the most impressive geomorphic features in the Los Angeles area. The fault is recognized by juxtaposition of rock types, shearing and crushing along the fault trace, and by linear land forms (geomorphology). The fault is primarily a thrust fault that has thrust the ancient igneous

and metamorphic rocks of the San Gabriel Mountains up and over young Quaternary-age alluvial deposits. The fault zone is very complex and over much of its length comprises several subparallel branches along the northern edge of the San Fernando and San Gabriel valleys (Figure 2-1). The fault may also be divided into segments along length, each with somewhat different rupture characteristics and histories.

The poor documentation of Quaternary faulting on the Sierra Madre fault makes it difficult to assess its earthquake capability. Based on worldwide empirical fault-length/earthquake-magnitude relationships (Wells and Coppersmith, 1994), the Sierra Madre fault is capable of producing earthquakes in the 7.0 to 7.5 magnitude range (Dolan et al., 1995). If the fault ruptures one of the segments independently, earthquakes of $M = 7.0$ are more likely; if more than one segment ruptures together, larger earthquakes are possible.

About 20 km of the westernmost part of the Sierra Madre fault ruptured the ground surface during the 1971 San Fernando earthquake ($M_w = 6.7$). The 1971 event was characterized by reverse faulting along a fault dipping about 45° to 50° northerly. In 1991, a magnitude 5.8 earthquake occurred below the San Gabriel Mountains at a depth of about 16 km and is generally believed to have occurred on the Clamshell-Sawpit branch of the Sierra Madre fault zone. The best available information indicates that large earthquakes on the Sierra Madre fault occur sometime between a few hundred years to a few thousand years (~5,000 years according to Crook et al., 1987). Geological and paleoseismological studies by Rubin et al. (1998) suggest that two prehistoric ruptures within the past 15,000 years had large displacements typical of earthquakes in the $M = 7.0$ to 7.5 range.

Reliable geological information on the slip rate of the Sierra Madre fault is scarce and the average time between large ground rupturing earthquakes is poorly known. Some geological studies have indicated that the average rate of displacement for the Sierra Madre fault may be as high as about 3 to 4 mm/year. The California Geological Survey uses a slip rate of 2.0 mm/yr (± 1.0 mm).

Malibu Coast, Santa Monica, Hollywood Fault System (Southern Frontal Fault system)

One of the major fault systems in the Los Angeles Basin is along the southern edge of the Santa Monica Mountains separating Mesozoic plutonic rocks from Tertiary and Quaternary sedimentary rocks. The fault system consists of the Santa Monica and Hollywood faults and smaller segments such as the Malibu Coast and Potrero faults (see Figure 2-1). Together, these faults form the southern boundary fault of the Santa Monica Mountains.

The Santa Monica Mountains rise abruptly to 500 to 600 m above the Los Angeles Basin floor and are indicative of a large vertical component of faulting. Earthquake focal mechanisms and local geologic relationships suggest reverse faulting with a subordinate left-lateral component. Investigations in the past decade or so (e.g. Davis et al., 1989; Dolan et al., 1995) postulate that the Santa Monica and Hollywood fault are predominantly strike-slip features and that the mountains are underlain by a separate, but related, blind thrust fault. The Metro Rail Red Line tunnel through the Hollywood segment of the fault system revealed a major shear zone with the plutonic rocks of the Santa Monica Mountains, uplifted over Quaternary alluvium and colluvium. The fault

zone consists of a northerly dipping fault with about a 100-meter-wide sheared gouge zone.

There have been no large earthquakes associated with Western Transverse Ranges southern boundary fault zone in historical time, but geological studies (Dolan et al., 1997, 2000a, 2000b) have documented Holocene faulting within the zone. Geological data indicate the recurrence intervals for large earthquakes are very long and appear to be on the order of a few thousand years; The Hollywood fault appears to have had one surface rupturing event in Holocene time (Dolan et al., 1997; 2000) with an average recurrence interval in the range of about 4,000 to 6,000 or 7,000 years. The Santa Monica fault has had two or probably three events in the past 16,000-17,000 years suggesting an average recurrence interval of about 7,000-8,000 years (Dolan et al., 2000).

Documented slip rates are less than 1.0 mm/yr but this estimate suffers from lack of data on the lateral slip. The California Geological Survey (2003) assumes a slip rate up to about 1.0 mm/yr (± 0.5 mm). The great length of the fault system suggests that it is capable of generating a large earthquake ($M \sim 7.5$) but the discontinuous nature of faulting suggests that faults may behave independently and perhaps a smaller maximum earthquake ($M \sim 6.5$ to 7.0) is more appropriate. Dolan et al (1997) postulated a $M_w = 6.6$ event for the Hollywood fault, and Dolan et al. (2000) postulated an $M = 6.9-7.0$ event for the Santa Monica fault.

Raymond Hill Fault

The Raymond Hill fault or as commonly referred to, the Raymond fault. The Raymond Hill fault is about 26 km long and extends approximately east-west through the communities of San Marino, Arcadia, and South Pasadena (Figure 2-1).

The Raymond Hill fault is characterized by left-lateral oblique reverse slip. This fault dips at about 75 degrees to the north. The rate of slip is between 0.10 and 0.22 mm/yr. The fault has been considered by some geoscientists to be interconnected with the Hollywood fault because they have similar trends and similar types of displacement. However, the disparity between recurrence intervals and the age of latest surface rupture suggests they are discrete features.

The most recent major rupture occurred in Holocene time, about 1000 to 2000 years ago (Weaver and Dolan, 2000). There is geological evidence of at least eight surface-rupturing events along this fault in the last 40,000 +/- years. At least five surface ruptures occurred in the past 40,000 years. However, four of these events occurred between 31,500 and 41,500 years ago (Weaver and Dolan, 2000). This indicates that surface ruptures occur over very irregular intervals and may be more random than systematic.

Elysian Park Fold and Thrust Belt

The Elysian Park Fold and Thrust Belt (EPFT) was initially a concept by Davis et al (1989) who postulated that the Los Angeles area is underlain by a deep master detachment fault, and that most of the folds and faults in the region result from slip along the detachment causing folding and blind thrust faulting at bends and kinks in the detachment fault. Shaw and Suppe (1996) further developed and expanded the

detachment/blind thrust model. They proposed several zones of subsurface faulting and folding consisting of the Elysian Park trend, the Compton-Los Alamitos trend, and the Torrance-Wilmington trend. Few of these thrust ramps have actually been seen in well data or seismic-reflection surveys because the postulated features are generally at depths beyond the reach of drilling or seismic-reflection methods. The detachment/blind thrust model was initially embraced primarily because the 1987 Whittier Narrows earthquake occurred in proximity to one of the postulated thrust ramps beneath the Elysian Park fold belt. At present most seismic hazard analyses recognize only the Upper Elysian Park Thrust (see Figure 2-1).

Recurrence-interval estimates range from 340 to 1,000 years. Oskin et al. (2000) model the Upper Elysian Park thrust as extending from the Hollywood fault to the Alhambra Wash fault with a slip rate of 0.8 to 2.2 mm/yr and magnitude 6.2 to 6.7 earthquakes with recurrence intervals in the range of 500 to 1300 years. The California Geological Survey, following the lead of Oskin et al. (2000), models the Upper Elysian Park thrust as a feature about 18 km long and dipping 50° northeasterly with a slip rate estimate of about 1.3 ± 0.4 mm/yr.

Puente Hills Fault System

The Puente Hills Thrust fault system (PHT) is the name currently given to a series of northerly dipping subsurface thrust faults (blind thrusts) extending about 40-45 km along the eastern margin of the Los Angeles Basin. Shaw and Shearer (1999) synthesized oil-company geophysical data and seismicity to interpret three discrete thrust faults underlying the La Brea/Montebello Plain, Santa Fe Springs Plain, and Coyote Hills.

Down-dip projection of the Santa Fe Springs segment extends to the approximate depth of the 1987 Whittier Narrows earthquake which Shaw and Shearer (1999) relocated to about 15 km depth. The close association of seismicity to the fault projections indicates that the fault is seismically active. Shaw and Shearer proposed that the Puente Hills fault system is capable of generating about magnitude 6.5 to 7.0 earthquakes and has a slip rate of between 0.5 to 2.0 mm/yr.

Subsequent work on the fault system (Shaw et al., 2002) infers that the en echelon segments of the Puente Hills Thrust are related and displacements are gradually transferred from one segment to the next. Using empirical data on rupture area, magnitude, and coseismic displacement, Shaw et al. (2002) estimated earthquakes of M_w 6.5 to 6.6 for single segments and M_w 7.1 for a multi-segment rupture. The recurrence intervals for these events are on the order of 400 to 1,320 years for single events and 780-2600 years for magnitude 7.1 events.

Paleoseismological studies using trenching and borings at the surface projection of the Santa Fe Springs fault (Dolan et al., 2003) identified four buried folds. This deformation was interpreted to be a result of subsurface slip associated with $M_w = 7.0 \pm$ earthquakes within the past 11,000 years.

The most recent seismic hazard model by the California Geological Survey (2003) used a slip rate of 0.7 ± 0.4 mm/yr.

2.3 Probabilistic Seismic Ground Motion Criteria

2.3.1 Design Earthquakes – Probabilistic Seismic Hazard Spectra

As previously described, Metro earthquake design policy for both aerial and underground structures has been based on a two level probabilistic design approach since 1983, namely:

1. An operating design earthquake (ODE) defined as an earthquake event likely to occur only once in the design life, where structures are designed to respond without significant structural damage and
2. A maximum design earthquake (MDE) defined as an earthquake event with a low probability of occurring in the design life, where structures are designed to respond with repairable damage and to maintain life safety.

Current Metro design criteria assume a design life of 100 years. To establish probabilistic seismic ground motion criteria, design earthquake motions are defined as follows:

	<u>Probability of Exceedance</u>	<u>Return Period</u>
Operating Design Earthquake (ODE)	50% in 100 years	144 years (say 150 years)
Maximum Design Earthquake (MDE)	4% in 100 years	2475 years (say 2500 years)

Note that similar probabilistic criteria have been adopted by other rail transit agencies in the United States, including those in Seattle and New York.

The MDE and ODE levels of horizontal ground shaking are best developed based on probabilistic seismic hazard analyses due to the large degree of variation (or uncertainty) in the observed ground shaking in the strong motion database. A probabilistic approach can better take into account the uncertainty parameters in evaluating strong ground characteristics for design, including earthquake magnitude recurrence intervals for source zones and ground motion attenuation relationships. This philosophy is also consistent with the approach in other major projects for critical structures.

Probabilistic seismic hazard analyses to determine site specific design spectra require four major steps as shown in Figure 2.4. In step 1, Seismic Source Identification, the seismic sources capable of generating strong ground motions at the project site(s) are identified and the geometries of these sources (i.e. their location and spatial extent) are defined. In Step 2, Magnitude-Recurrence, a recurrence relationship describing the rate at which various magnitude earthquakes are expected to occur is assigned to each of the identified seismic sources. Step 1, Seismic Source Identification, and Step 2, Magnitude-Recurrence, together may be referred to as seismic source characterization. In Step 3, Ground Motion Attenuation, an attenuation relationship that describes the relationship between earthquake magnitude, site-to-source distance, and the ground motion parameter of interest is assigned to each seismic source for a specific ground stiffness condition (characterized by a shear wave velocity). In Step 4, Probability of Exceedance, the results from the first three steps are integrated to produce a curve

relating the value of the ground motion parameter of interest at the site(s) of interest to the probability that it will be exceeded over a specified time interval.

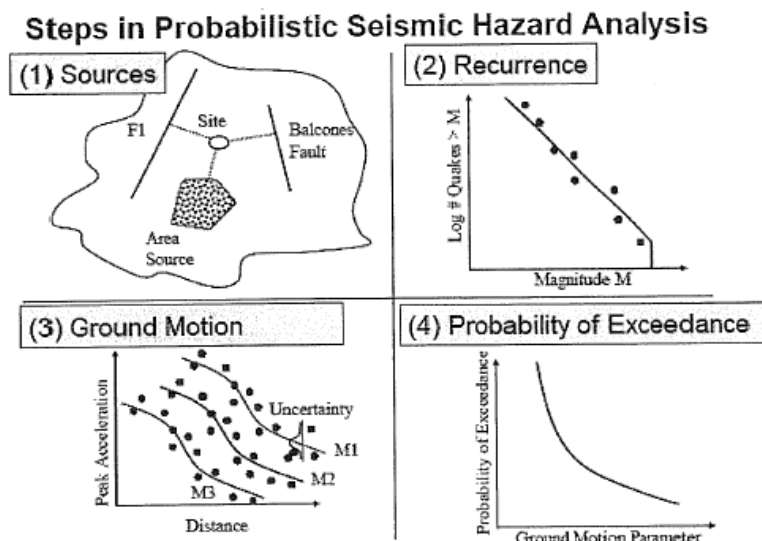

Figure 2-4 Steps in Probabilistic Seismic Hazard Analysis

The data used for Steps 1 through 3 are continually updated by seismologists and geologists as new research findings are debated and published. The probabilistic seismic ground motion criteria documented in previous Metro design guidelines used data which has been superseded by recent research. In particular, the most recent 2008 update of the USGS National Seismic Hazard Maps (USGS, 2008) incorporates the development of the Next Generation of Attenuation (NGA) relationships (Power et al. 2008) developed as a result of a 5 year research program coordinated by the Pacific Earthquake Engineering Research Program (PEER) in partnership with the USGS and the Southern California Earthquake Center (SCEC). In addition, updated fault parameters and fault source models were adopted from information developed by the Working Group on California Earthquake Probabilities (WGCEP) detailed in a 2008 WGCEP Report by Wells et al. (2008).

As a result of the above developments, Metro has adopted the 2008 USGS update of the National Probabilistic Seismic Hazard Analyses (PSHA) as a basis for their probabilistic ground motion criteria. In particular, ODE and MDE Spectral Accelerations for specific sites, should be developed using data available in the 2009 PSHA Interactive Deaggregation USGS Web Site as discussed below and illustrated in the example documented in Section 2.3.5.

2.3.2 Ground Motion Criteria- Aerial Structures

The seismic design of aerial and surface structures for Metro transportation projects, should be based on site specific ODE and MDE ground surface 5% damped acceleration spectra developed using the USGS 2009 PSHA Interactive Deaggregation Web Site (USGS, 2009). Input data requires the site coordinates and the average shear wave velocity in the top 30 meters (V_s^{30}) of the site. Spectral ordinates may be plotted for available period values of 0.0 (PGA), 0.1, 0.2, 0.3, 0.5, 1.0, 2.0, 3.0, 4.0 and 5.0 seconds. Note that the use of V_s^{30} replaces the use of site Soil Class Factors A-F used

in older versions of USGS evaluations of site spectra. For the ODE, a 50% probability of exceedance in 100 years is available at the Web Site. However for the MDE, it is necessary to use a value of 2% in 50 years (equivalent to 4% in 100 years).

The determination of the design spectra requires values of V_s^{30} to be obtained at a site, where V_s^{30} is the average shear wave velocity for the upper 30 meters of the site profile. In situ geophysical methods for determining V_s^{30} are documented in the Caltrans Geotechnical Services Design Manual (Caltrans 2009). Methods include using the Oyo Suspension P-S Logger (Nigbor and Imai, 1994), downhole shear wave measurements such as the Seismic CPT cone and Rayleigh Surface Wave Inversion Methods. Data from geophysical methods are required for final design. The use of empirical methods based on correlations of V_s^{30} with SPT blow counts, CPT data or undrained shear strengths of cohesive soils as described by Caltrans (2009), may be used for initial estimates in preliminary design, but only used for final design if supplemented by site specific calibration against geophysical data.

In addition to the MDE spectral evaluations described above, where Metro aerial structures impact a Caltrans “right-of-way”, an additional evaluation of Caltrans design spectra is required, to check that the Caltrans spectral ordinates do not exceed the MDE values. In 2009 Caltrans adopted revised procedures for design spectrum development. The procedures use both a deterministic procedure based on Maximum Credible Earthquakes (MCE) on a revised California fault database and a probabilistic procedure using a 1000 year return period based on the 2008 update of the USGS Hazard Maps. For both procedures, spectral ordinate adjustments are made for near fault effects and deep basin effects. Input data requires the site coordinates and the average shear wave velocity in the top 30 meters (V_s^{30}) of the site. The online internet link for the web based spectra development procedure is http://dap3.dot.ca.gov/shake_stable/. The design spectrum is developed from the envelope of the deterministic and probabilistic spectral ordinates.

Note that the procedures for long period spectral ordinate corrections for deep basin effects documented by Caltrans should also be applied to the MDE USGS probabilistic spectra for Metro seismic design.

An example of both the Metro and Caltrans procedures for a specific site is given in Section 2.3.5.

2.3.3 Ground Motion Criteria- Underground Structures

The seismic design of underground structures for Metro transportation projects (including underground stations and tunnels) should be based on MDE subsurface ground motions expressed as site specific ground shear strains, velocities or displacements in the vicinity of the station walls or tunnels as required by the soil-structure interaction analyses discussed in the Supplemental Seismic Design Criteria (SSDC) for Underground Structures. The determination of the above ground motion parameters requires site specific one-dimensional non-linear site response analyses using computer programs such as SHAKE 91 (Idriss and Sun, 1992). The acceleration time histories required for such analyses should be determined from spectral matching procedures (described in paragraph 2.3.4 below) where the “rock outcrop” spectra is defined by the MDE ground acceleration from the USGS 2009 PSHA Website (USGS 2009), using a V_s^{30} value associated with a “rock outcrop” depth of at least 50 feet below the invert of the structure. (Note that the spectra should be adjusted for deep basin

effects as previously discussed.) Appropriate strain dependent shear modulus and damping values for analyses should be assigned to site soil or rock strata at the site using accepted relationships such as those for cohesive soil (Vucetic and Dobry, 1991) and sands (EPRI, 1993), and where the maximum shear modulus is determined from measured shear wave velocities.

2.3.4 Spectral Matching of Acceleration Time Histories

As noted above, acceleration time histories are required for nonlinear analyses of aerial structures or for non-linear site response analyses for underground structures. The use of spectrum compatible input time histories has been widely used for major seismic design projects and is adopted for Metro projects. The concept ensures that a broad range of frequency content is included in the ground motion time history generated for design.

A reference ground motion time history (usually an actual earthquake record) is chosen as a “seed” or start-up motion and is gradually modified through an interactive process so that the response spectrum and the modified time history is compatible with the target spectrum. The recorded time histories should be chosen to match the site soil conditions and dominant earthquake magnitude and distance of the dominant earthquakes contributing to the design spectrum. The earthquake record database available through the Consortium of Organizations for Strong-Motion Observation Systems (COSMOS) is a valuable source of records. The web address is <http://db.cosmos-eq.org>.

Various methods have been developed to perform spectrum matching. A commonly used frequency domain method adjusts the Fourier amplitude spectrum based on the ratio of the target response spectrum to the time history response spectrum while keeping the Fourier phase of the reference history fixed. An alternative time domain approach for spectral matching adjusts the time history in the time domain by adding wavelets to the reference time history. A formal optimization procedure for this type of time domain spectral matching was first proposed by Kaul (1978) and was extended to simultaneous matching at multiple damping values by Lilhan and Tseng (1987, 1988). Abrahamson (1998) also documents a procedure. While this approach is more complicated than the frequency domain method, it has good convergence properties.

There are relative merits for both the frequency and time domain approaches. However, the best approach would be that which makes the least changes to the startup motion. Figure 2-5 shows an example of spectral matching for using 1940 Imperial Valley earthquake recorded at El Centro, as a start-up motion.

Due to the variability in time history characteristics from “seed” motions, a minimum of three time histories should be used for nonlinear response analyses, and maximum response values of interest from the analyses used for design. A preferable approach is to use seven sets of time histories, and adopt the mean response values for design.

2.3.5 Example- Site Spectra Development

An example of the recommended approach to develop MDE and ODE Acceleration Response Spectra at a Bridge Site is shown in Figure 2-6. The site is the Metro Gold Line Bridge near Union Station, where it is assumed the value of V_s^{30} is 1000ft/sec. Note

that the MDE spectrum is only slightly greater than the Caltrans deterministic spectrum for periods greater than 1.0 seconds. The adjustment factors for deep basin effects at the site were negligible. However, the Caltrans adjustments factors for near fault effects (The Puente Hills blind thrust fault) were significant for periods greater than 0.5 seconds. Near fault adjustment factors to probabilistic MDE spectra are not recommended for design at this time, due to uncertainties in the appropriate methodology for making such an adjustment to a probabilistic spectrum.

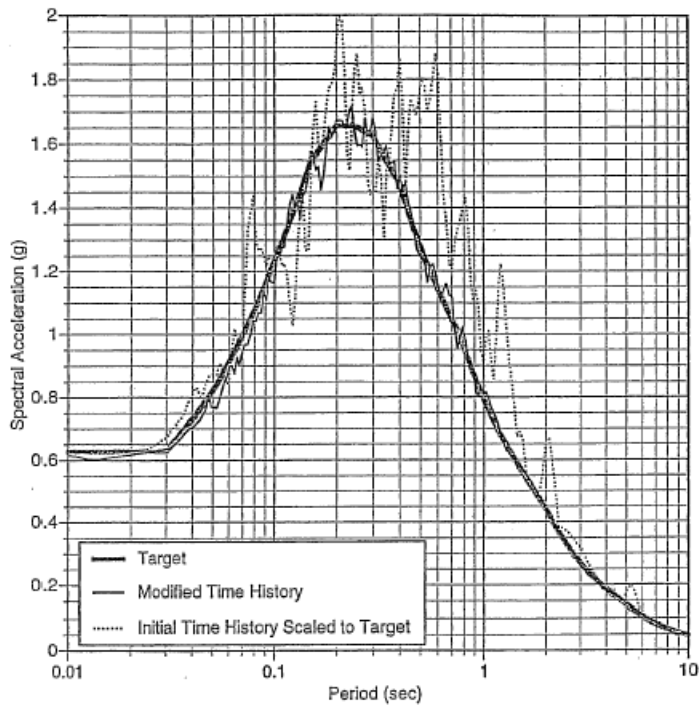

Figure 2-5 Example of Acceleration Spectral Matching

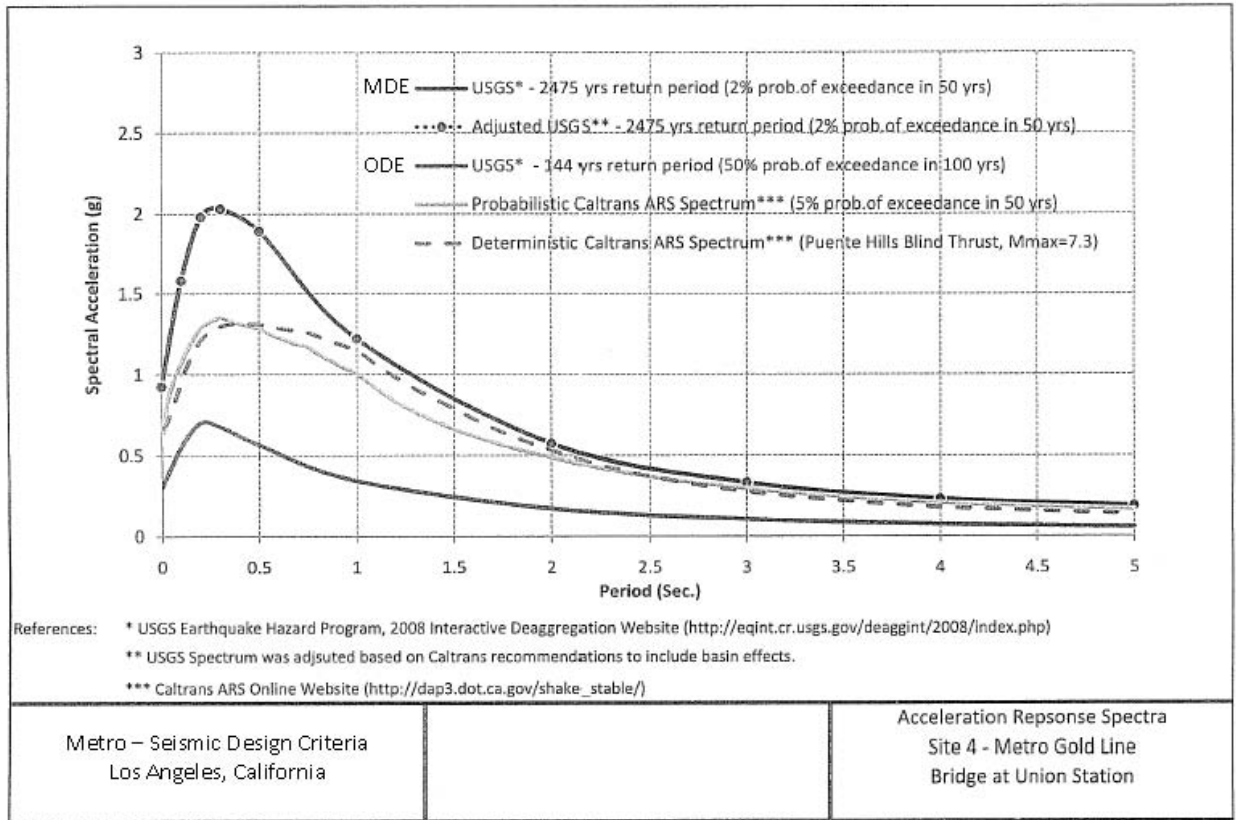

Figure 2-6 Example showing MDE and ODE Spectra at a Bridge Site

2.4 Surface Fault Rupture Displacement

2.4.1 Fault Rupture Potential Evaluation

Fault rupture refers to the shearing displacements that occur along an active fault trace when movement on the fault extends to the ground surface, or the depth of a tunnel or underground station. Displacements can range from inches to several feet. Because fault displacements tend to occur abruptly, often across a narrow zone, fault rupture can be very damaging to a bridge, or tunnel structure.

Fault ruptures generally are expected to occur along existing traces of active faults. Faults are generally considered to be active faults with a significant potential for future earthquakes and displacements if they have experienced displacements during the past approximately 11,000 years (Holocene time).

Design philosophy for fault crossings recognizes that it is difficult to prevent damage in a strong earthquake, given the magnitude of fault displacements. For tunnels, the general design philosophy now widely accepted for a fault crossing is to “overbore” the tunnel, so that if the maximum design earthquake-induced displacement occurs, the tunnel is still of sufficient diameter to fulfill its function after repairs. The overbored section is taken through the fault zone with transition zones narrowing to the regular tunnel diameter.

The overbored sections are backfilled with easily re-minable and crushable material such as “cellular” concrete. Such an approach was adopted for the North Outfall Replacement Sewer Project Tunnel when crossing the Newport Inglewood Fault, and was adopted for the Metro Red Line Segment 3 Hollywood Fault crossing. For blind thrust faults in the vicinity of underground structures, it may be necessary to estimate surface uplift, as in the case of the Eastside Coyote Escarpment (Habioma, et al., 2006).

Bridges crossing or immediately adjacent to active faults may be subjected to large differential displacements between adjacent piers and/or abutments due to surface faulting. A conservative design approach should be adopted if surface faulting is possible. Continuous spans are preferable. Adding extra confinement in the plastic hinge zones of the substructure might be used to provide the maximum displacement capacity. Simple spans can tolerate relative movements, but it will be difficult to ensure that the spans do not become unseated. To minimize this risk, very generous support should be provided.

The additional redundancy in continuous superstructures that are integral with their substructures will reduce the probability of total collapse. There is, however, a practical limit to the amount of relative displacement across a fault that can be accommodated in a monolithic structure. One alternative is to support a continuous superstructure on elastomeric bearings at each pier and abutment. These bearings can accommodate relatively large displacements and still provide an elastic restoring force to the superstructure. Restrainers may also be provided if gross movements are expected. Note that acceleration records from recent earthquakes indicate vertical accelerations in excess of 1.0 g in the near-field of the fault. In these situations, integral construction is preferred, but if elastomeric bearings are used, vertical restrainers should be provided to limit the uplift.

If an active fault exists in the vicinity of a project site detailed fault evaluations should be carried out by the geotechnical consultant oriented toward:

1. Establishing the location of the fault or fault zone relative to a project,
2. Establishing the activity of the fault if it traverses the project site, that is, the timing of the most recent slip activity on the fault, and
3. Evaluating fault rupture characteristics; i.e., amount of fault displacement, width of zone of displacement, and distribution of slip across the zone for horizontal and vertical components of displacement. For blind thrust faults, an assessment of surface uplift may be required. A probabilistic assessment of the likelihood of different magnitudes of fault displacement during the life of the structure may also be useful in decision-making.
4. The ground rupture characteristics for the design earthquake on the fault (e.g. type of faulting as illustrated in Figure 2-7), amount of slip and distribution into strike-slip and dip-slip components, and width of the zone of ground deformation.

A walk-down of the site and its vicinity should be conducted to observe unusual topographic conditions and evaluate any geologic relationships visible in cuts, channels, or other exposures.

Faults obscured by overburden soils, site grading, and/or structures can potentially be located by one or more techniques. Geophysical techniques such as seismic reflection

or refraction surveying provide a remote means of identifying the location of steps in a buried bedrock surface and the juxtaposition of earth materials with different elastic properties. Geophysical surveys require specialized equipment and expertise, and their results may sometimes be difficult to interpret. Trenching investigations are commonly used to expose subsurface conditions to a depth of 15 to 20 feet. While expensive, trenches have the potential to locate faults precisely and provide exposures for assessing their slip geometry and slip history. Borings can also be used to assess the nature of subsurface materials and to identify discontinuities in material type or elevation that might indicate the presence of faults.

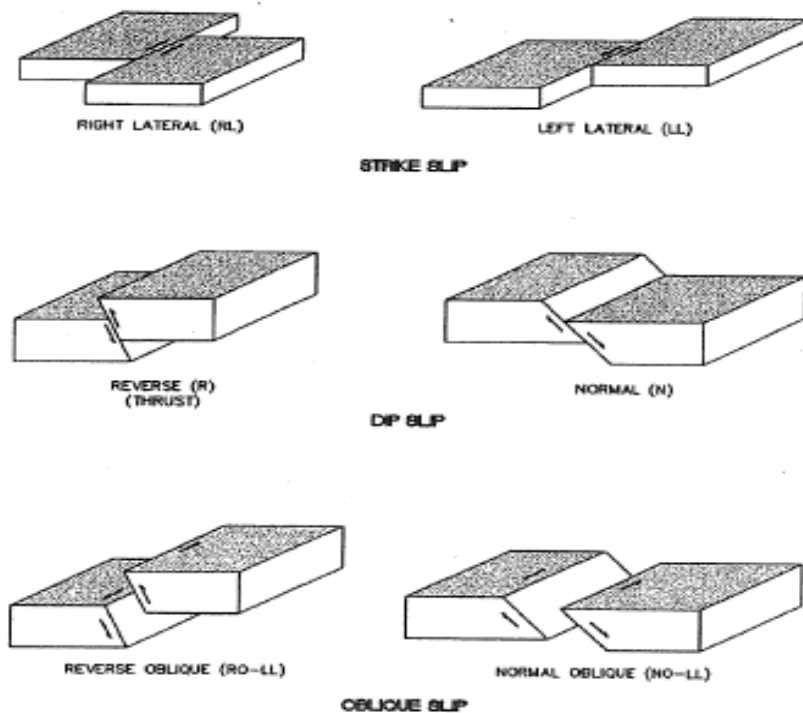

Figure 2-7 Types of earthquake faults

If it is determined that faults pass beneath the site, it is essential to assess their activity by determining the timing of the most recent slip(s) as discussed below. If it is determined, based on the procedures outlined below, that the faults are not active faults, further assessments are not required.

The most definitive assessment of the recent history of fault slip can be made in natural or artificial exposures of the fault where it is in contact with earth materials and/or surfaces of Quaternary age (last 1.8 million years). Deposits might include native soils, glacial sediments like till and loess, alluvium, colluvium, beach and dune sands, and other poorly consolidated surficial materials. Surface might include marine, lake, and stream terraces, and other erosional and depositional surface. A variety of age-dating techniques, including radiocarbon analysis and soil profile development, can be used to estimate the timing of the most recent fault slip.

2.4.2 Fault Rupture Characteristics and Displacement Estimates

Several methods can be used to estimate the size of future displacements. These include:

1. Observations of the amount of displacement during past surface-faulting earthquakes.
2. Empirical relations that relate displacement to earthquake magnitude or to fault rupture length.

The most reliable displacement assessments are based on past events. Observations of historical surface ruptures and geologic evidence of paleoseismic events provide the most useful indication of the location, nature, and size of the future events. Where the geologic conditions do not permit a direct assessment of the size of past fault ruptures, the amount of displacement must be estimated using indirect methods. Empirical relations between displacement and earthquake magnitude based on historical surface-faulting earthquakes (e.g. Wells and Coppersmith, 1994) provide a convenient means for assessing the amount of fault displacement. An example of such a relationship is shown in Figure 2-8. In this example, maximum displacement along the length of a fault rupture is correlated with earthquake magnitude. Maximum displacement typically occurs along a very limited section of the fault rupture length. Relationships are also available for the average displacement along the rupture length. Data from well-documented historical earthquakes indicate that the ratio of the average displacement to the maximum displacement ranges between 0.2 and 0.8 and averages 0.5 (Wells and Coppersmith, 1994). Other methods for calculating the average size of past displacements include dividing the cumulative displacement by the number of events that produced the displacement, and multiplying the geologic slip rate by the recurrence interval.

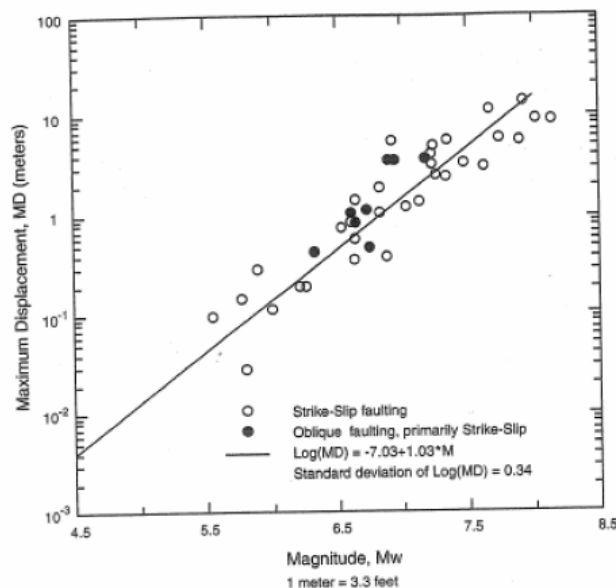

Figure 2-8

Relationship between maximum surface fault displacement and earthquake moment magnitude for strike-slip faulting (after Wells and Coppersmith, 1994)

Predicting the width of the zone and the distribution of slip across the zone of surface deformation associated with a surface faulting event is more difficult than predicting the total displacement. The best means for assessing the width of faulting is site-specific trenching that crosses the entire zone. Historical records indicate that the width of the zone of deformation is highly variable along the length of a fault. No empirical relationships having general applicability have been developed that relate the size of the earthquake or the amount of displacement on the primary fault trace to the width of the zone or to the amount of secondary deformation. The historical record indicates, and fault modeling shows that the width of the zone of deformation and the amount of secondary deformation tend to vary as a function of the dip of the fault and the sense of slip. Steeply dipping faults, such as vertical strike-slip faults, tend to have narrower zones of surface deformation than shallow-dipping faults. For dipping faults, the zone of deformation is generally much wider on the hanging wall side than on the foot wall side. Low-angle reverse faults (thrust faults) tend to have the widest zones of deformation.

2.4.3 Probabilistic Fault Displacement Evaluation

Probabilistic methods for assessing the hazard of fault rupture have been developed that are similar to the probabilistic seismic hazard analysis (PSHA) methods used to assess earthquake ground motions (Youngs et al., 2003). A PSHA for fault rupture defines the likelihood that various amounts of displacement will be exceeded at a site during a specified time period.

REFERENCES

1. Benioff, H., 1938, "The determination of the extent of faulting with application to the Long Beach earthquake," *Bulletin of the Seismological Society of America*, vol. 28, p. 77-84.
2. California Department of Water Resources, 1961, "Planned utilization of the ground water basins of the Coastal Plain of Los Angeles County, Appendix A, Ground Water Geology," Department of Water Resources Bulletin No. 104.
3. California Geological Survey, 2003, "The revised 2002 California probabilistic seismic hazard maps," California Geological Survey website by Cao, T., Bryant, W.A., Rowshandel, B., Branum, D., and Wills, C.J., June 2003.
4. Converse Ward Davis Dixon, Earth Science Associates and Georesources Inc., 1981, Geotechnical Investigation Report, Southern California Rapid Transit District Metro Rail Project.
5. Crook R.C. Jr., and Proctor, R.J., 1992, "The Santa Monica and Hollywood faults and the southern boundary of the Transverse Ranges province," in "Engineering geology practice in southern California," Association of Engineering Geologists, Southern California Section, Special Publication 4, p. 233-246.
6. Dolan, J.F., Sieh, K., Rockwell, T.K., Yeats, R.S., Shaw, J., Suppe, J., Huftile, G.J., and Gath, E.M., 1995, "Prospect for larger or more frequent earthquakes in the Los Angeles metropolitan region, California," *Science*, Vol. 267, p. 199-205.
7. Dolan J.F., Sieh, K., Rockwell, T.K., Guphill, P. and Miller, G., 1997, Active tectonics, paleoseismology, and seismic hazards of the Hollywood fault, northern Los Angeles basin, California," *Geological Society of America Bulletin*, vol. 109, p. 1595-1616.

8. Dolan, J.F., Stevens, D., Rockwell, T.K., 2000a, "Paleoseismologic evidence for an early- to mid-Holocene age of the most recent surface rupture on the Hollywood fault, Los Angeles, California," *Bulletin of the Geological Society of America*, vol. 90, p. 334-344.
9. Dolan, J.F., Sieh, K., Rockwell, T.K., 2000b, "Late Quaternary activity and seismic potential of the Santa Monica fault system, Los Angeles, California," *Geological Society of America Bulletin*, vol. 112, p. 1559-1581.
10. Dolan, J.F., Christofferson, S.A., and Shaw, J.H., 2003, "Recognition of paleoearthquakes on the Puente Hills blind thrust fault, California," *Science*, vol. 300, p. 115-118.
11. Freeman, S.T., Heath, E.G, Guptill, P.D., and Waggoner J.T., 1992, "Seismic hazard assessment, Newport-Inglewood fault zone," *in* "Engineering Geology practice in southern California," Association of Engineering Geologists, Southern California Section, Special Publication 4, p. 211-231.
12. Gath, Eldon, 1992, "Geologic Hazards and Hazard Mitigation in the Los Angeles Region," *in* "Engineering Geology practice in southern California," p. 3-27.
13. Grant, L.B., Waggoner, J.T., Rockwell, T.K., and Von Stein, C., 1997, "Paleoseismicity of the north branch of the Newport-Inglewood fault zone in Huntington Beach, California, from cone penetrometer test data," *Bulletin of the Seismological Society of America*, vol. 87, p. 277-293.
14. Habimana, J., Elioff, A. and Moriwaki, Y., 2006, "Numerical modeling to estimate the effect of permanent distortion, induced by a blind thrust fault earthquake on a light rail underground station, North American Tunneling, 2006.
15. Hauksson, E., 1987, "Seismotectonics of the Newport-Inglewood fault zone in the Los Angeles Basin, southern California." *Bulletin of the Seismological Society of America*, vol. 77, p. 539-561.
16. Hauksson, E., 1990, "Earthquakes, faulting, and stress in the Los Angeles basin," *Journal of Geophysical Research*, vol. 95, p. 15,365-15,394.
17. Kramer, Steven L., "Geotechnical Earthquake Engineering, Prentice Hall, 1996.
18. McNeilan, T.W., Rockwell, T.K., and Resnick, G.S., 1996, "Style and rate of Holocene slip, Palos Verdes fault, southern California," *Journal of Geophysical Research*, vol. 101, p. 8317-8334.
19. Nigbor, Robert L., Imai, Tsuneo, 1994, "The Suspension P-S Velocity Logging Method," 13th International Conference Soil Mechanics and Foundations Engineering, New Delhi.
20. Oskin, M., and Sieh, K.E., 1998, "The Elysian Park anticlinorium; surficial evidence of an active blind reverse fault beneath downtown Los Angeles," *Geological Society of America, Abstracts with Programs, Cordilleran Section*, no. 6471, p. 57.
21. Power, M., Chiou, B., Abrahamson, N., Borzorgnia, T., Shantz, T., and Roblee, C., "An Overview of the NGA Project," *Earthquake Spectra*, Vol. 21, No. 1, Feb. 2008.
22. Schell, B.A., 1991, "Seismotectonic zonation and seismic hazard analyses in southern California," *Fourth International Conference on Seismic Zonation, Proceedings*, vol. 2, p. 19-26.

23. Shaw, J.H., Plesch, A., Dolan, J.F., Pratt, T.L., and Fiore, P., 2002, "Puente Hills blind-thrust system, Los Angeles, California," *Bulletin of the Seismological Society of America*, vol. 92, p. 2946-2960.
24. Shaw, J.H., and Shearer, P.M., 1999, "An elusive blind-thrust fault beneath metropolitan Los Angeles," *Science*, vol. 283, p.1516 (5 March)
25. Shaw, J.H., and Suppe, J., 1996, "Earthquake hazards of active blind thrust faults under the central Los Angeles basin, California," *Journal of Geophysical Research*, vol. 101, p. 8623-8642.
26. Shlemon, R.J., Elliott, P., and Franzen, S., 1995, "Holocene displacement history of the Newport-Inglewood, North Branch fault splays, Santa Ana River floodplain, Huntington Beach, California," *Geological Society of America, Abstracts with Programs*, vol. 27, p. A-375.
27. USGS, 2008, USGS Website @ http://earthquake.usgs.gov/research/hazmaps/products_data/2008/data/.
28. USGS, 2009, Probabilistic Seismic Hazard Analysis Interactive Deaggregation Website (beta) @ <http://equint.cr.usgs.gov/deaggint/2008/index.php>.
29. Vedder, J.G., Greene, H.G., Clarke, S.H., and Kennedy, M.P., 1986, "Geologic map of the mid-southern California continental margin," California Division of Mines and Geology, California Continental Margin Geologic Map Series, Map No. 2A.
30. Vucetic, M. and Dobry, R., 1991, "Effect of Soil Plasticity on Cyclic Response" *Journal of Geotechnical Engineering*. ASCE, Vol. 117, No. 1, pp. 89-107.
31. Ward, S.N., 1994, "A multidisciplinary approach to seismic hazard in southern California," *Bulletin of the Seismological Society of America*, vol. 84, p. 1293-1309.
32. Wells, D. and K. Coppersmith, 1994, "Updated empirical relationships among magnitude, rupture length, rupture area, and surface displacement," *Bulletin of the Seismological Society of America*, vol. 84, p. 974-1002.
33. Yerkes, R.F., McColloch, T.H., Schoellhamer, J.E., and Vedder, J.G., 1965, "Geology of the Los Angeles basin, California - an introduction," U.S. Geological Survey, Professional Paper 420-A.
34. Youngs et al., 2003, "A Methodology for Probabilistic Fault Hazard Displacement Analysis (PFDHA)," *Earthquake Spectra*, Vol. 19, No. 1, February.
35. Transportation Research Board, "Seismic Analysis and Design of Retaining Walls, Buried Structures, Slopes and Embankments," NCHRP Report 611, 2008.
36. NCHRP, Project 12-70, "Seismic Analysis and Design of Retaining Walls, Buried Structures, Slopes and Embankments," Draft Final Report Volume 2, Recommended Specifications, Commentaries and Example Problems, 2008.
37. Tokimatsu, K. and Seed, H.B., "Evaluation of Settlements in Sand due to Earthquake Loading," *Journal of Geotechnical Engineering*, ASCE, Volume 113, No. 8, pp. 861-878, 1987.

CHAPTER 3

SUPPLEMENTARY SEISMIC DESIGN CRITERIA (SSDC)

Part A METRO SSDC FOR AERIAL GUIDEWAYS AND BRIDGES

3A1.0 SCOPE

This Seismic Design Criteria Revision updates the latest documents prepared in 2003 for Metro Gold Line Eastside Extension. This consisted of the Metro's Design Criteria Section 5 references to seismic design of structures and Section 5 Appendix Chapter 3 Part A for Aerial Guideways and Bridges and the addition of Section 5 Appendix Chapter 3 Part B for Underground Structures (Both referred to herein as Metro SSDC).

These design criteria apply to the design of normal aerial guideway, bridges, and structures to resist the effects of earthquake motions. Normal guideway and bridges should be considered to be new and conventional slab, beam, girder, and box girder superstructures with spans not exceeding 500 feet. These criteria do not apply to Critical/Essential Bridges as defined by the Caltrans BDS.

These criteria are intended to be used by designers who are experienced in the field of the bridge design and are familiar with the recent procedures being used by Caltrans.

Some special structures and structural systems involve unique design and construction problems not covered by this criteria, the provisions in this criteria govern only where applicable. Retrofit repairs, alterations and additions necessary for the preservation and restoration of historic buildings, bridges and structures may be made without strict conformance to this criteria when authorized by Metro and the governing agency. The use of any material or method of construction and design not specifically prescribed herein may be used upon approval by Metro and the governing agency.

All new structures shall be designed to resist the earthquake forces (EQ) and the ground displacement stipulated in these criteria. Aerial structures are defined as those elevated guideway structures which support Metro vehicles.

The requirement for peer review of the design work for Metro aerial structures and bridges will be determined by the Metro on a case by case basis.

3A2.0 DESIGN POLICY

The Metro Rail Project is a large-scale public project in an area highly susceptible to major earthquakes. Further, earthquake-initiated failures of selected structures and systems could lead to loss of life. For this reason Metro has developed special earthquake protection criteria for the project.

As previously discussed, the guiding philosophy of earthquake design for the project is to provide a high level of assurance that the overall system will continue operating during and after an Operating Design Earthquake (ODE). Operating procedures assume safe shut down and inspection before returning to operation. Damage, if any, is expected to

be minimal and to minimize the risk of derailment of a train on the bridge at the time of the earthquake. Further, the system design will provide a high level of assurance that public safety will be maintained during and after a Maximum Design Earthquake (MDE). The definition of ODE and MDE levels as discussed in Chapter 2 is as follows:

The ODE is defined as the earthquake event which has a return period of 150 years. Such an event can reasonably be expected to occur during the 100-year facility design life. The probability of exceedance of this level of event is approximately 50 percent during the facility life.

The MDE is defined as the earthquake event which has a return period of 2500 years. Such an event has a small probability of exceedance during the facility life. This probability is approximately four percent or less.

3A3.0 PERFORMANCE OBJECTIVES

For the Operating Design Earthquake (ODE) which is likely to occur about once during the normal life expectancy, there shall be no interruption in rail service during or after the ODE. When subjected to the ODE, structures shall be designed to respond essentially in an elastic manner as defined by Caltrans Seismic Design Criteria, Section 3.2, Material Properties for Concrete Components, latest version. There shall be no collapse, and no damage to primary structural elements. Only minimal damage to secondary structural elements is permitted, and such damage shall be minor and easily repairable. The structure shall remain fully operational immediately after the earthquake, allowing a few hours for inspection.

For the Maximum Design Earthquake (MDE) which has a low probability of being exceeded during the normal life expectancy, some interruption in rail service is permitted to allow for inspection and repairs following the MDE. When subjected to the MDE, it is acceptable that the structures behave in an inelastic manner. There shall be no collapse and no catastrophic inundation with danger to life, and any structural damage shall be controlled and limited to elements that are easily accessible and can be readily repaired. The structure should be designed with adequate strength and ductility to survive loads and deformations imposed on the structure during the MDE, thereby preventing structure collapse and maintaining life safety.

In no case is the design to result in less seismic performance capability than that required by Caltrans BDS. To substantiate that this requirement has been met, a design check calculation using Caltrans criteria may be necessary.

3A4.0 CODES AND STANDARDS

These criteria make reference to, incorporate, are based on, or modify the following principal design codes:

1. For bridges and aerial structures that support rail transit loadings, except as otherwise noted herein, use the current Caltrans Seismic Design Criteria, latest edition, but with Metro specified rail transit loading. All the above is referred to throughout these criteria as "Caltrans SDC".

Caltrans Seismic Design Criteria (Current Version) shall supersede all provisions for seismic design, analysis, and detailing of bridge contained in the *AASHTO LRFD Bridge Design Specifications*. The Caltrans Seismic Design Criteria is used in conjunction with the Extreme Event I Load Combination specified in Caltrans BDS.

Where Caltrans SDC is not applicable, use the most appropriate code provided below.

2. For bridges that support railroad loadings, use the design requirements of the applicable railroad. In the absence of such requirements, use AREMA, Manual for Railway Engineering, Volume 2, Section 9, Seismic Design for Railway Structures, Latest Edition.
3. For bridges that support highway loading, use the design requirements of the applicable jurisdiction. In the absence of such requirements, use the Caltrans SDC.
4. For additional applicable codes, see the Structural/Geotechnical Criteria Section 5.1.2, Reference Data, and Section 5.1.3 Reference Codes.

3A5.0 DESIGN RESPONSE SPECTRA

Chapter 2 of this Metro SSDC describes the seismic design ground motion criteria to be used for bridges and aerial guideways. It provides an overview of the Geologic and Seismic Environment related to existing or proposed Metro transportation alignments including descriptions of the regional stratigraphy, tectonics, historical seismicity, and principal active faults. Chapter 2 also describes the use of probabilistic seismic hazard analyses for the development of the site specific Operating Design Earthquake (ODE) and Maximum Design Earthquake (MDE) ground motion criteria for bridges and aerial guideways.

The ground motion response spectra for this supplemental criteria are developed by the geotechnical consultant for each project site.

3A6.0 DESIGN GROUND MOTIONS

All aerial structures and bridges shall be designed to resist earthquake motions in accordance with Metro Seismic Design Ground Motion Criteria, Chapter 2. Where conflicts occur, the more critical will control. In some cases, aerial structures with bridges may be under other agency jurisdictions (such as Caltrans) and design criteria specified elsewhere. If seismic ground motion spectra are greater than those specified in Chapter 2, the former should be used for design.

Elements of above ground station structures not subject to rail transit loading shall be designed to resist earthquake motions in accordance with the applicable building codes of Section 5.1.

3A7.0 METHODS OF ANALYSIS

A complete aerial guideway or bridge system shall be composed of a single frame or a series of frames separated by expansion joints and/or articulated construction joints. A guideway or bridge shall be composed of a superstructure and a supporting substructure. Individual frame sections shall be supported on their respective substructures, consisting of piers, single column or multiple column bents that are supported on their respective foundations.

The determination of the seismic response of a bridge shall include the development of an analytical model followed by the response analysis of the analytical model to predict the resulting dynamic response for component design. Both the development of the analytical model and the selected analysis procedure shall be dependant on the seismic hazard (See Chapter 2), the selected seismic design strategy and the complexity of the guideway or bridge. The level of refinement in the analytical model and analytical procedure to be used shall be subject to the approval of Metro.

For additional information, see Caltrans SDC, latest version.

Due to the soil/structure interaction (SSI), three directional foundation soil springs shall be included in all of the analytical models. For in-structure displacement compatibility, column P- Δ effect shall also be included.

3A8.0 DESIGN FORCES, MOMENTS AND DISPLACEMENTS

Load Case 1: 100% of the absolute value of forces, moments, and displacements in transverse direction are added to 30% of the corresponding force and moments from the longitudinal and vertical directions.

Load Case 2: 100% of the absolute value of forces, moments, and displacements in the longitudinal direction are added to 30% of the corresponding forces and moments from the transverse and vertical directions.

Load Case 3: 100% of the absolute value of forces, moments, and displacements in vertical direction are added to 30% of the corresponding forces and moments from the transverse and longitudinal directions.

All aerial structures and bridges shall be designed to resist earthquake motions in accordance with Metro Supplemental Seismic Design Criteria (Metro SSDC) and as provided in Section A4.0. Where Metro SSDC and Caltrans SDC conflict, the more critical will control.

Use the Caltrans BDS method for the design of all structural components and connections. Each component and connection shall satisfy each of the following LRFD limit states, unless noted otherwise in another area of this criteria.

LRFD employs specified limit states to achieve the objectives of constructability, safety, and serviceability. See the Structural/Geotechnical Criteria Section 5.2.17. A Limit State is defined as a condition beyond which a structure or structural component ceases to satisfy the provisions for which it was designed. The resistance of components and connections are determined, in many cases, on the basis of inelastic behavior, although the force effects are determined by using elastic analysis. This inconsistency is common

to most current specifications as a result of incomplete knowledge of inelastic structural action.

LRFD uses Service Limit states to provide for restrictions on stress, deformations, and crack width under regular service conditions. (See Structural/Geotechnical Criteria Section 5.2.17.1, Service limit state.)

LRFD uses extreme event limit states to ensure the structural survival of structures during major earthquakes. Extreme Event Limit States are considered to be unique occurrences whose return period may be significantly greater than the design life of the bridge. Extreme Event IA is the load combination relating to the operational use of the guideway that incorporates the ODE level seismic event. Extreme Event Limit State I is the load combination relating to the operational use of the guideway that incorporates the MDE level seismic event. (See Structural/Geotechnical Criteria Section 5.2.17.4, Extreme event limit state.)

For loading combinations, refer to Section 5.2.20 of the Structural/Geotechnical Criteria.

3A9.0 STRUCTURAL DESIGN

3A9.1 Properties for Material Components

For concrete and reinforcing steel, apply Caltrans SDC, Section 3.2 Material Properties for Concrete Components. In areas where this code is silent, the following shall apply.

Reinforcing steel shall be ASTM grade A706, with a yield strength between 66 ksi and 78ksi. Use a yield strength of 66 ksi unless restricted otherwise by the Building Code requirements.

The required performance for rebar development lengths is based on the Building Code's implemented ACI 318-08 and Caltrans BDS (See Structural/Geotechnical Criteria Section 5.1.3.C.1. The following statements provide additional requirement for use of #14 and #18 bars in seismic zones:

Straight #14s and #18s utilized in seismic zones shall be confined over the full length of the bar development zone. All other rebar development criteria and modification factors of the Building Codes referenced Chapter 12 of ACI 318-08, and Caltrans BDS implemented AASHTO LRFD Bridge Design Specifications, Section 5.11 shall be applied to straight bars.

When hooked #14s are utilized in seismic zones they shall be confined over the entire straight length of the bar development zone. No reduction factors may be applied to the basic development length of a standard hook in tension. In seismic zones #18 bars shall not be hooked. All other rebar development criteria and modification factors of Building Codes referenced Chapter 12 of ACI 318-08, and Caltrans BDS implemented AASHTO LRFD Bridge Design Specifications, Section 5.10 shall be applied to hooked bars.

3A9.2 Superstructure

The ultimate capacity of the superstructure in the area over the bent caps shall be designed for the larger of the forces resulting from ODE analysis or from the column plastic hinging.

The width of the superstructure assumed to be available to resist these forces shall be taken as one half of the column width plus the depth of the superstructure, on either side of the column centerline. For open soffit girders, follow Caltrans SDC 7.2.1.

When it is not possible to place the reinforcement within the above specified area, designers should then consider such details as:

- Using thicker soffits and/or top slabs.
- Widening the cap (but not more than $d/2$).
- Using dropped cap.

Make all top and bottom bent cap main reinforcement continuous. If this is physically impossible, then at least 75% of reinforcement shall be made continuous. No lap splices shall be allowed in the main cap reinforcement.

3A9.3 Columns

Design column for essentially elastic behavior at the ODE level. At the MDE design check, make certain the plastic hinges occur at the top and/or bottom of the column. To transfer shear forces from plastic hinges, the joint shear and the additional longitudinal/transverse reinforcement shall be designed in accordance with section A9.4.

Column deflection capacity must be larger than displacement demand at MDE level. The following interaction equation must be satisfied:

$$\Delta_D < \Delta_C$$

Where:

- Δ_D = Maximum displacement demand
- Δ_C = Displacement capacity

Displacement demands amplification due to P- Δ effects must be considered.

Column reinforcement ratio should be kept under 4% to reduce congestion due to added joint reinforcement. It will also help in keeping the joint shear stresses lower than the maximum of $12(f'_c)^{1/2}$.

For column flares design and detailing, refer to SDC, Section 7.6.5.

3A.9.4 Joint Shear

For joint shear, refer to Caltrans BDS implemented AASHTO LRFD Bridge Design Specifications, with California Amendments and AASHTO Guide Specifications for LRFD Seismic Bridge Design, latest editions.

The maximum shear stress in the enlarged joint area is to be limited to $12(f'c)^{1/2}$.

3A9.5 Outrigger Bents

In addition to the worst combination for a particular design case, the outrigger bents shall be designed for dead load forces increased and decreased by 50%.

For short outriggers (i.e. outrigger length less than the larger cap cross-section dimension), an additional check for torsional shear friction is to be performed.

Outrigger joints can be pinned at the top to reduce torsional moments in the cap beam.

3A9.6 Expansion Joints

Design expansion joints, calculate the movement rating "MR" and gap size "a" according to the following conditions.

$$MR = 2\Delta EQL + \Delta T/2 > MR \text{ required by BDS.}$$

$$a = \Delta EQL - \Delta PS/2 + \Delta T/4$$

or,

$$a = EQU - \Delta PS/2 - 2-1/2 \text{ (inches)}$$

whichever is greater, but not less than "a" required by Caltrans BDS.

ΔEQL = Longitudinal Displacement at ODE level.

EQU = Longitudinal Displacement at MDE level.

ΔT = total thermal displacement range.

ΔPS = total prestress shortening.

Round MR and "a" up to nearest 1/2 inch and 1/4 inch respectively.

3A9.7 Abutments, Piers, and Walls

At the ODE level, maintain an open gap longitudinally and provide full transverse load capacity. At the MDE level, consider the contribution of the approach slab in the longitudinal direction. The procedure is as follows:

For abutments, piers and walls, refer to Caltrans SDC.

3A9.8 Foundations

For both ODE and MDE, footings shall be provided with enough vertical carrying capacity within a 45° cone directly under the column, to carry the unfactored column dead load reaction.

3A9.9 Expansion Joint Hold-downs

For both ODE and MDE, hold down devices shall be provided at all supports and intermediate hinges where the vertical seismic forces (Load Case 1 and 2) oppose and exceed 50% of the dead-load reaction or Load Case 3 produces net uplift. The minimum seismic design force for the hold-down device shall be the greater of:

Load Case 1 & 2

10% of the dead load reaction or
1.20 times the net uplift force.

Load Case 3

Net uplift force

3A10.0 MINIMUM SEAT WIDTH

The seismic design displacements for determining seat width shall be the greater of either those obtained from analysis at the MDE level using spectra and effective column stiffness or as specified in Caltrans BDS implemented AASHTO LRFD Bridge Design Specifications, with California Amendments and AASHTO Guide Specifications for LRFD Seismic Bridge Design, latest editions.

3A11.0 RESTRAINERS

The detailed design of restrainers shall be based upon the philosophy and guidelines set forth in Caltrans BDS.

3A12.0 SEISMIC BASE ISOLATION

A base isolation system may be considered in the design of special bridges and aerial structures upon approval by Metro and should conform to the following subsections.

Design of all base isolated bridges and aerial structures shall conform to Caltrans BDS implemented AASHTO Guide Specifications for Seismic Isolation Design, latest edition with the following modifications.

3A12.1 Analysis Procedure

All base isolated bridges and aerial structures shall be analyzed by the following two methods for both ODE and MDE and the most stringent case shall govern the design of the structural elements and isolation system.

Method 1: Response Spectrum Analysis

An equivalent linear response spectrum analysis shall be performed using the appropriate ground motion response spectra (horizontal and vertical) as defined in Chapter 2 of this criteria.

Method 2: Time-History Analysis

A non-linear time-history analysis of the combined structure and isolator system shall be performed. This method will incorporate the actual force deflection characteristics of the systems together with a minimum of three ground motion time histories that represent the seismicity of the site, and must be approved by Metro.

3A12.2 Isolation System

The isolation system shall be analyzed using deformational characteristics. The isolation system shall be analyzed with sufficient detail to:

- Account for the spatial distribution of isolator units.
- Calculate translation, in both horizontal directions, and torsion of the structure above the isolation interface, considering the most disadvantageous location of mass eccentricity,
- Assess overturning/uplift forces on individual isolator units, and
- Account for the effects of vertical load, bilateral load and/or the rate of loading if the force deflection properties of the isolation system are dependent on one or more of these attributes.

No tension is allowed in isolators.

3A12.3 Design Forces for Seismic Performance

The isolated structural above and below the isolated system shall be designed using all the provision for a non-isolated structure. The design and detailing of seismic isolation devices shall be designed in accordance with the provisions of Caltrans BDS and the AASHTO Guide Specifications for Seismic Isolation Design, whichever is more critical.

The seismic design force for columns and piers shall not be less than the forces resulting from a lateral force applied at the isolator location corresponding to the yield level of a softening system, or the static friction level of a sliding system, or the ultimate capacity of a sacrificial wind-restraint system.

3A12.4 Structure and Rail Interaction

Special analysis shall be performed to evaluate the interaction between the structural components and track work above it; special attention shall be given at the expansion joints and abutments. At ODE, no damage to the rails or no transverse residual gap between adjacent segments of rails is allowed. At MDE, the level and extent of the damage to the rails shall be defined.

3A13.0 Seismic Design for Ground and Embankment Stability

For seismic design for ground and embankment stability, apply the National Cooperative Highway Research Program Reports, Seismic Analysis and Design of Retaining Walls, Buried Structures, Slopes, and Embankments (TRB 2008, NCHRP 2008).

The seismic stability and potential permanent deformation of sloping ground or embankments supporting aerial guideway and bridges along proposed alignments shall be investigated. Investigations should included evaluation of the potential for ground

liquefaction and related deformations. The evaluations and associated analyses should be displacement based leading to the determinations of potential lateral deformations of slopes or embankments and ground settlement. Total settlement and lateral ground deformations under ODE seismic events shall not be allowed to exceed 2 inches to allow for track re-leveling or re-alignment. Larger deformations may be allowed for MDE events on a case-by-case basis on approval by Metro.

The stability of slopes and embankments shall be evaluated using either (1) the seismic coefficient approach in a pseudo-static stability analysis or (2) the slope-displacement method as described in the NCHRP Project 12-70 Reports on the “Seismic Analysis and Design of Retaining Walls, Buried Structures, Slopes and Embankments,” (Transportation Research Board, 2008, NCHRP, 2008). If Method (1) quasi-static slope stability analyses lead to factors of safety less than 1.1, slope performance shall be evaluated using Method (2) where displacements are computed using Newmark time-history analyses. If computed displacements lead to unacceptable performance, appropriate mitigation measures shall be incorporated in the design.

If potentially liquefiable soils are identified along proposed alignments, liquefaction susceptibility shall be determined using the procedures documented in the AASHTO Bridge Design Specifications (AASHTO 2010, Article 10.5.4). The requirements for site investigation to assess liquefaction potential are described in Article 10.4 of the AASHTO Specifications. The liquefaction potential assessment should consider the impact of the following effects where liquefaction is judged to occur:

1. Loss of strength of liquefied layers (post liquefaction residual strength)
2. Flow failures, slope deformations
3. Post liquefaction ground settlement

The displacement performance of slopes and embankments underlain by liquefied soils may be evaluated in a similar manner to non-liquefiable cases, except residual strengths of liquefied soils are used in analyses (NCHRP, 2008, AASHTO, 2008). The post-liquefaction settlement of liquefied soil layers may be determined using procedures documented by Tokimatsu and Seed (1997)

For sites where liquefaction occurs around aerial structure or bridge foundations, structures should be analyzed and designed for two configurations as documented in AASHTO, Article 10.5.4.2:

1. Non liquefied site soil configuration
2. Liquefied site soil configurations

For the latter case, residual strengths of liquefied soil layers are used for lateral and axial deep foundation response analyses. For those sites where liquefaction related permanent lateral ground displacements are determined to occur, the effects on pile performance should be evaluated. Downdrag forces on piles due to post liquefaction settlement should also be evaluated. If the above impact assessments yield unacceptable performance of the structures, appropriate mitigation measures shall be incorporated into the design.

REFERENCES

1. State of California Department of Transportation (Caltrans) Bridge Design Specification (BDS) referenced "LRFD Bridge Design Specifications", Fourth Edition, 2007, (Including 2008 and 2009 Interims), by the American Association of State Highway and Transportation Officials, (AASHTO).
2. State of California Department of Transportation (Caltrans), 2009, "Seismic Design Criteria, (SDC) Version 1.5."
3. State of California Department of Transportation (Caltrans), August 6, 2009, Memorandum, "Implementation of Caltrans 2009 Seismic Design Procedure," Kevin Thompson, James E. Davis, and Dolores Valls, Division of Engineering Services.
4. State of California Department of Transportation (Caltrans), August 12, 2009, Memorandum, "Quality Control/Quality Assurance for the 2009 Seismic Design Procedures," Dolores Valls, Division of Engineering Services.
5. California Building Standards Commission, 2007, "California Building Code, California Code of Regulations, Title 24," based on the 2006 International Building Code.
6. American Concrete Institute, 2008, "Building Code Requirements for Structural Concrete and Commentary", (ACI 318-08, & ACI 318R-08).
7. American Institute of Steel Construction, 2005, "Code of Standard Practice for Steel Buildings and Bridges," 13TH Edition, (LRFD).
8. American Railway Engineering and Maintenance of Way Association (AREMA), 2008, "Manual for Railway Engineering."
9. National Fire Protection Association, 2008, "Standard for Road Tunnels, Bridges, and Other Limited Access Highways (NFPA 502)."
10. Allen, T.M., 2005, "Development of Geotechnical Resistance Factors and Downdrag Load Factors for LRFD Foundation Strength Limit State Design, Publication No. FHWA-NHI-05-052. Federal Highway Administration.
11. Applied Technology Council, 1996, "Improved Seismic Design Criteria for California Bridges: Resource Document," Publication 32-1, Redwood City, California.
12. Seyed, M, April 1993, "Seismic Bridge Analysis Package", Caltrans Special Analysis Section.
13. Transportation Research Board, "Seismic Analysis and Design of Retaining Walls, Buried Structures, Slopes and Embankments," NCHRP Report 611, 2008.
14. NCHRP, Project 12-70, "Seismic Analysis and Design of Retaining Walls, Buried Structures, Slopes and Embankments," Draft Final Report Volume 2, Recommended Specifications, Commentaries and Example Problems, 2008.

15. Tokimatsu, K. and Seed, H.B., "Evaluation of Settlements in Sand due to Earthquake Loading," Journal of Geotechnical Engineering, ASCE, Volume 113, No. 8, pp. 861-878, 1987.

CHAPTER 3**SUPPLEMENTARY SEISMIC DESIGN CRITERIA****Part B METRO SSDC FOR UNDERGROUND STRUCTURES****3B1.0 SCOPE**

This Supplemental Seismic Design Criteria (SSDC) for Underground Structures replaces previous criteria (2003) used for Metro Gold Line Eastside Extension project. The criteria also replaces the “Supplemental Criteria for Seismic Design of Underground Structures” published in June 1984 by Metro Rail Transit Consultants.

The criteria and codes specified herein shall govern seismic design of Metro owned underground facilities including cut-and-cover subway structures, mined tunnels and stations, U-sections, shafts, earth-retaining structures, and other non structural and operationally critical components and facilities supported on or inside Metro underground structures.

These criteria address the general seismic design conditions that apply to the Metro Rail Project. Where there are cases of special designs encountered that are not specifically covered in these criteria, an appropriate technical source shall be determined and the appropriate procedure developed for the design.

3B2.0 DESIGN POLICY

The Metro Rail Project is a large-scale public project in an area highly susceptible to major earthquakes. Further, earthquake-initiated failures of selected structures and systems could lead to loss of life. For this reason Metro has developed special earthquake protection criteria for the project.

The guiding philosophy of earthquake design for the project is to provide a high level of assurance that the overall system will continue operating during and after an Operating Design Earthquake (ODE). Operating procedures assume safe shut down and inspection before returning to operation. Further, the system design will provide a high level of assurance that public safety will be maintained during and after a Maximum Design Earthquake (MDE). The definition of ODE and MDE levels is as follows:

The ODE is defined as the earthquake event which has a return period of approximately 150 years. Such an event can reasonably be expected to occur during the 100-year facility design life. The probability of exceedance of the ODE event is approximately fifty percent (50%) during the 100-year facility life.

The MDE is defined as the earthquake event which has a return period of approximately 2,500 years. Such an event has a small probability of exceedance during the 100-year facility life. The probability of exceedance of the MDE event is approximately four percent (4%) during the 100-year facility life.

3B3.0 PERFORMANCE OBJECTIVES

For the Operating Design Earthquake (ODE) which is likely to occur about once during the normal life expectancy, there shall be no interruption in rail service during or after the ODE. When subjected to the ODE, structures shall be designed to respond essentially in an elastic manner. There shall be no collapse, and no damage to primary structural elements. Only minimal damage to secondary structural elements is permitted, and such damage shall be minor and easily repairable. The structure shall remain fully operational immediately after the earthquake, allowing a few hours for inspection.

For the Maximum Design Earthquake (MDE) which has a low probability of being exceeded during the normal life expectancy, some interruption in rail service is permitted to allow for inspection and repairs following the MDE. When subjected to the MDE, it is acceptable that the structures behave in an inelastic manner. There shall be no collapse and no catastrophic inundation with danger to life, and any structural damage shall be controlled and limited to elements that are easily accessible and can be readily repaired. The structure should be designed with adequate strength and ductility to survive loads and deformations imposed on the structure during the MDE, thereby preventing structure collapse and maintaining life safety.

3B4.0 CODES, STANDARDS AND REFERENCES

The structural design for seismic loading shall meet applicable portions of the current editions of the codes, manuals or specifications identified in Section 5 - Structural/Geotechnical Criteria and those given below.

Unless otherwise noted herein, the relevant portions of the stated edition of the code or standard shall apply. If a new edition, interim specification or amendment is issued before the design is completed, the design shall conform to the new requirement to the extent practical, subject to Metro approval.

1. Technical Manual for Design and Construction of Road Tunnels – Civil Elements, March 2009 (FHWA-NHI-09-010), U.S. Department of Transportation, Federal Highway Administration, National Highway Institute.
2. Seismic Analysis and Design of Retaining Walls, Buried Structures, Slopes, and Embankment, NCHRP Report 611, 2008 Transportation Research Board.
3. California Building Code, California Code of Regulations, Title 24, Part 2, California Building Standards Commission, based on the International Building Code. This code and its amendments is referred to herein as the Building Code.
4. Metro Rail Supplemental Seismic Design Criteria (Metro Rail SSDC), Chapter 2 – Seismic Design Ground Motion Criteria.

3B5.0 SEISMIC HAZARD AND DESIGN GROUND MOTION PARAMETERS

Seismic environment, seismic hazard analysis procedure and the design ground motion parameters for the Metro Rail Project are presented in Chapter 2 (Seismic Design Ground Motion Criteria) of the Metro Rail SSDC. For seismic design of underground structures, important seismic design ground motion parameters include (for both MDE

and ODE) design earthquake magnitudes, design site-to-source distances, design response spectra, design ground motion time histories (spectrum-compatible), design ground motion peak values, design soil shear displacement (or shear strain) profiles, and design fault rupture displacements and other relevant parameters.

3B6.0 GENERAL DESIGN PROCEDURE

The general procedure for seismic design of underground structures is based primarily on the ground deformation approach specified herein. During earthquakes, underground structures move together with the surrounding geologic media. Therefore, the structures are designed to accommodate the deformations imposed by the ground taking into consideration the effects of soil-structure interaction.

Underground tunnel structures undergo three primary modes of deformation during seismic shaking: ovaling/racking, axial, and curvature deformations. The ovaling/racking deformation is caused primarily by seismic waves propagating perpendicular to the tunnel longitudinal axis. Vertically propagating shear waves are generally considered the most critical type of waves for this mode of deformation (Figure 3B-1). The axial and curvature deformations are induced by components of seismic waves that propagate along the longitudinal axis (Figure 3B-2).

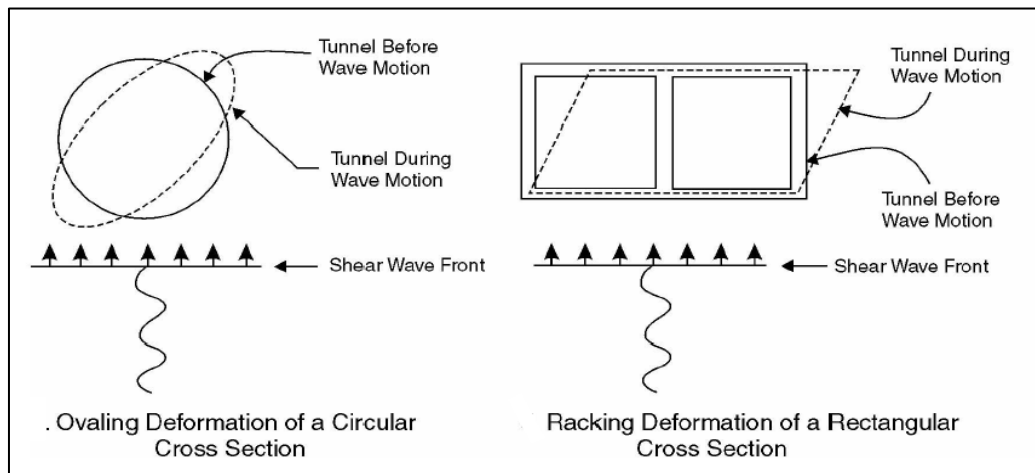

Figure 3B-1 Tunnel Transverse Ovaling and Racking Response to Vertically Propagating Shear Waves (Wang, 1993)

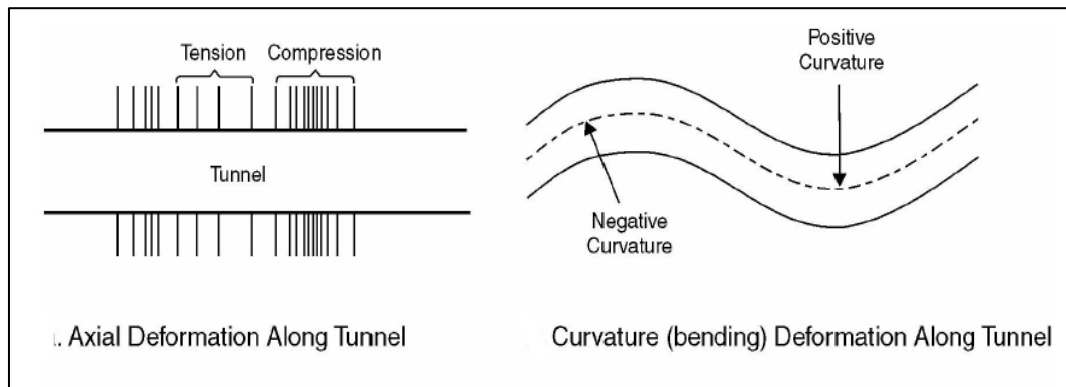

Figure 3B-2 Tunnel Longitudinal Axial and Curvature Response to Traveling Waves

3B7.0 BORED CIRCULAR TUNNELS

Bored circular tunnels include earth tunnel sections and rock tunnel sections, using either the precast concrete segmental lining or cast-in-place concrete lining. Design details for reinforced concrete tunnel lining shall be in accordance with the provisions of the California Building Code and Caltrans implemented AASHTO LRFD. Additional guidance in tunnel applications not generally covered in bridge and building codes is presented in FHWA-NHI-09-010 Report, “*Technical Manual for Design and Construction of Road Tunnels*”, Chapter 10. The design shall also comply with the requirements specified in Metro Rail Design Criteria Section 5 – Structural/Geotechnical.

3B7.1 Seismic Demands due to Ovaling Deformations

There are two general approaches to determining the seismic deformation of circular tunnels.

The first approach is based on closed form solution that accounts for soil-structure interaction effect. The closed form solution is based on the following assumptions: (1) the tunnel is of completely circular shape (without decks or walls inside) with uniform lining section, (2) surrounding soil is uniform, and (3) there is no interaction effect from adjacent tunnels or other structures.

The second approach is a numeric modeling approach that relies on mathematical models of the structures (including adjacent structures if relevant) to account for structural properties, varying soil stratigraphy and soil properties, loadings and deformations more rigorously. These structural models are generally run on computers with specialized software. If the actual soil-structure systems encountered in the field are more complex than the assumed conditions described above for the closed form solution approach which could lead to unreliable results, then the use of the numerical modeling approach should be adopted.

3B7.1.1 Closed Form Solution

For the closed form solution the seismic ovaling loads for the lining of bored circular tunnels is defined in terms of change of tunnel diameter (ΔD_{EQ}) caused by the vertically

propagating shear waves of the MDE and ODE ground motions. ΔD_{EQ} can be considered as seismic ovaling deformation demand for the lining. The procedure for determining ΔD_{EQ} is summarized as-follows:

1. Calculate the expected free field ground shear strains caused by the vertically propagating shear waves of the design earthquakes, for both MDE and ODE. The maximum free-field ground shear strains, γ_{max} , shall be derived at the elevation of the tunnel section that is of interest. The determination of the maximum free-field ground shear strain, γ_{max} , requires site-specific one-dimensional site response analyses using computer programs such as SHAKE 91 (Idriss and Sun, 1992). The acceleration time histories required for such analyses should be determined from spectral matching procedures (described in Chapter 2) where the "rock outcrop" spectra is defined by the MDE and ODE ground acceleration from the USGS 2009 PSHA Website (USGS 2009). In performing the site-specific site response analysis appropriate strain dependent shear modulus reduction curves and damping curves are to be assigned to site soil or rock strata at the site using accepted relationships such as those for cohesive soils (Vucetic Dobry, 1991) and sands (EPRI, 1993), and where the maximum shear modulus values are determined from measured in-situ shear wave velocities.
2. By ignoring the stiffness of the tunnel, which is applicable for tunnels in rock or very stiff/dense soils, the lining is assumed to conform to the distortion imposed on it by the surrounding ground with the presence of a cavity in the ground due to the tunnel excavation. The resulting diameter change of the tunnel is estimated as follows:

$$\Delta D_{EQ} = \pm 2\gamma_{max}(1 - \nu_m)D$$

where:

ν_m = Poisson's ratio of the surrounding ground

D = diameter of the tunnel

3. If the tunnel is stiff relative to the surrounding soil, the effects of soil-structure interaction shall be taken into consideration. The stiffness of the tunnel relative to the surrounding ground is quantified by the flexibility ratio, F, and compressibility ratio, C, which are measures of the flexural stiffness (resistance to ovaling) and ring compression or extension stiffness, respectively, defined as follows:

$$F = \frac{E_m(1 - \nu_c^2)R^3}{6E_c I_c(1 + \nu_m)}$$

$$C = \frac{E_m(1 - \nu_c^2)R}{E_c t(1 + \nu_m)(1 - 2\nu_m)}$$

where:

E_m = strain compatible elastic modulus of the surrounding ground

- E_c = elastic modulus of the concrete lining
- R = nominal radius of the concrete lining
- I_c = moment of inertia of the concrete lining (per unit width)
- ν_c = Poisson's ratio of the concrete lining
- ν_m = Poisson's ratio of the surrounding ground
- t = thickness of the concrete lining

The strain compatible elastic modulus of the surrounding ground E_m shall be derived using the effective strain-compatible shear modulus G_m obtained from the results of the site-specific site response analysis.

The moment of inertia of the concrete lining I_c per unit width shall be determined based on the expected behavior of the selected lining under the combined seismic and static loads, accounting for cracking and joints between segments and between rings as appropriate. The cracked section of concrete shall be used for bending stress as appropriate.

4. Derive the tunnel diameter change, ΔD_{EQ} , accounting for the soil-structure interaction effects using the following equation:

$$\Delta D_{EQ} = \pm \frac{1}{3} (K_1 F \gamma_{max} D)$$

where:

$$K_1 = \text{seismic ovaling coefficient} = \frac{12(1 - \nu_m)}{2F + 5 - 6\nu_m}$$

The seismic ovaling coefficient curves are presented in Figure 3B-3.

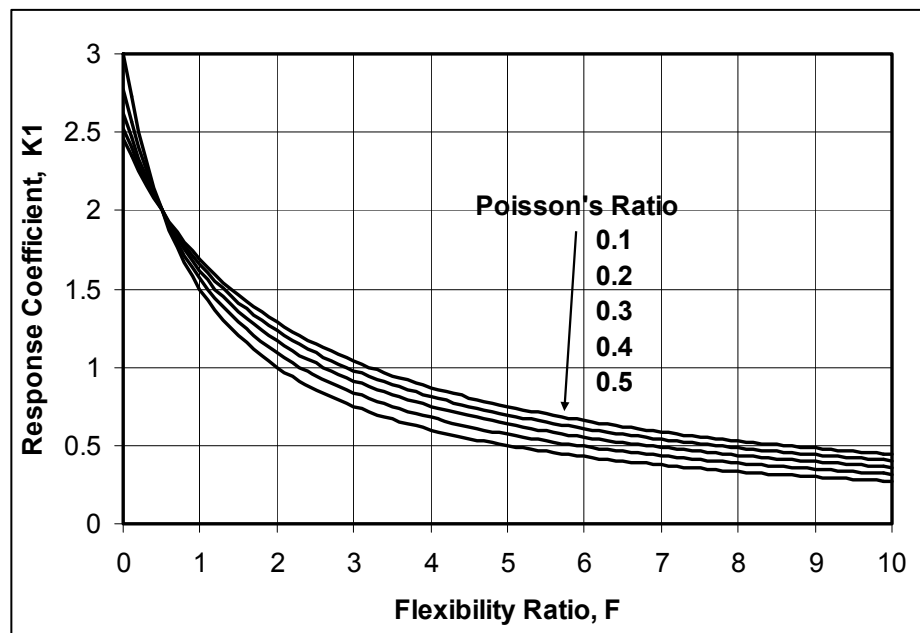

Figure 3B-3 Seismic Ovaling Coefficient, K_1

5. Derive the seismic loading effect, EQ, associated with the seismic ovaling deformation ΔD_{EQ} by using the loading combinations and load factors presented in Table 5-3 in Metro Rail Design Criteria, Section 5, Structural/Geotechnical:

If the tunnel lining is expected to behave in an essentially elastic manner and for lining that can be modeled with a uniform bending stiffness ($E_c I_c$), the internal seismic force EQ, expressed in terms of maximum thrust T_{max} per unit width and maximum bending moment M_{max} per unit width can be derived as follows:

$$T_{max} = K_2 \gamma_{max} \frac{E_m}{2(1 + \nu_m)} R$$

$$M_{max} = \frac{1}{6} K_1 \gamma_{max} \frac{E_m}{1 + \nu_m} R^2$$

where:

$$K_2 = 1 + \frac{F[(1 - 2\nu_m) - (1 - 2\nu_m)C] - 0.5C(1 - 2\nu_m)^2 + 2}{F[(3 - 2\nu_m) + (1 - 2\nu_m)C] + C(2.5 - 8\nu_m + 6\nu_m^2) + 6 - 8\nu_m}$$

The resulting bending moment induced maximum fiber strain, ϵ_m , and the hoop force (i.e., thrust) induced strain, ϵ_T , in the lining can be derived as follows:

$$\epsilon_T = K_2 \gamma_{max} \frac{E_m}{2(1 + \nu_m)} \cdot \frac{R}{E_c t}$$

$$\epsilon_m = \frac{1}{6} \cdot \frac{t}{2} K_1 \gamma_{max} \frac{E_m}{1 + \nu_m} \cdot \frac{R^2}{E_c I_c}$$

The lining coefficient K_2 , primarily used for the thrust response evaluation, is graphically presented in Figures B-4, B-5, and B-6 for Poisson's Ratio values of 0.2, 0.35 and 0.5, respectively.

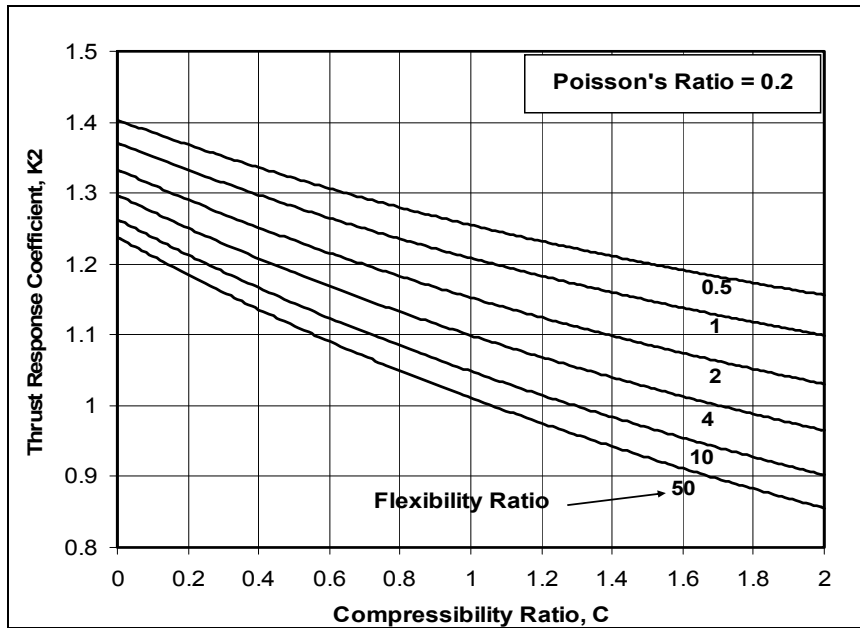

Figure 3B-4 Lining Response Coefficient, K_2 , for Poisson's Ratio = 0.2 (Wang, 1993)

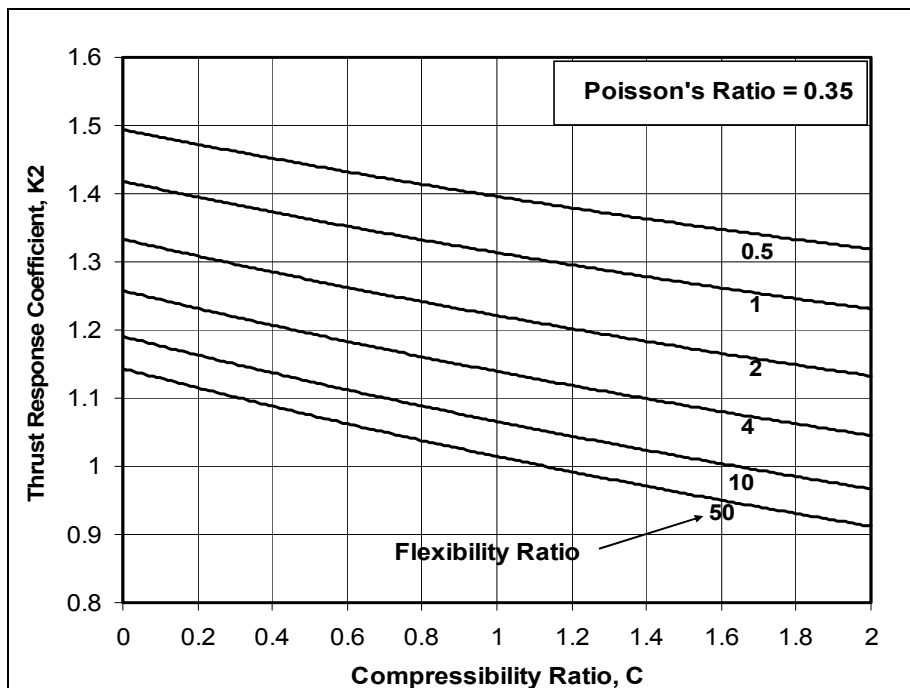

Figure 3B-5 Lining Response Coefficient, K_2 , for Poisson's Ratio = 0.35 (Wang, 1993)

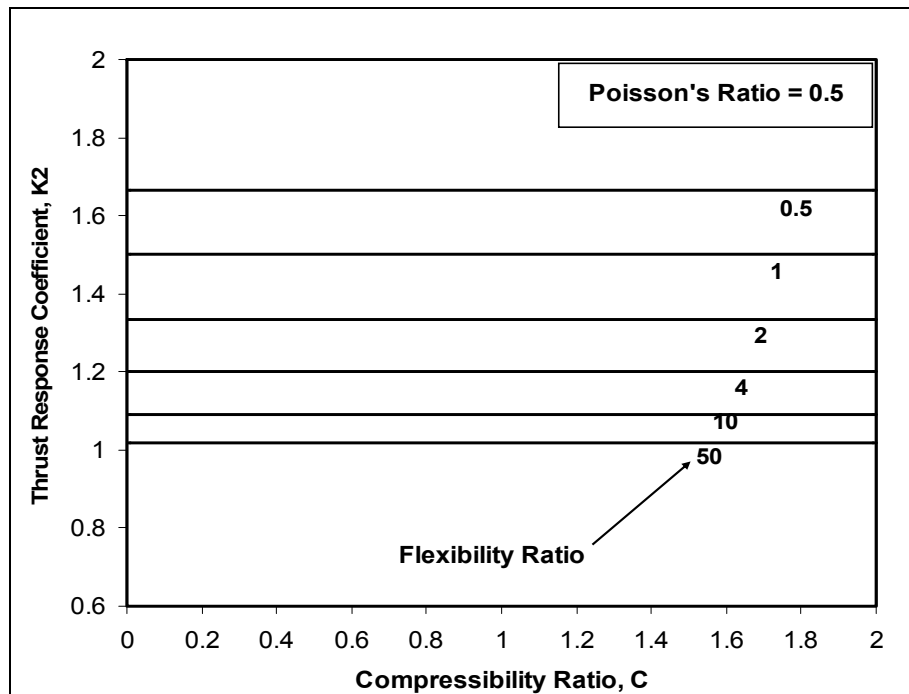

Figure 3B-6 Lining Response Coefficient, K_2 , for Poisson's Ratio = 0.5 (Wang, 1993)

The equations for T_{max} and ϵ_T , are based on a no-slip condition at the soil/lining interface, where relative slip movement between the exterior side of the tunnel lining and the surrounding soil is assumed not to occur. This no-slip assumption produces more conservative results for evaluating T_{max} and ϵ_T . On the other hand, more critical results are obtained for M_{max} and ϵ_m , as expressed by the equations presented above, by assuming a full-slip condition at the soil/lining interface.

If inelastic displacement is anticipated to occur in the tunnel lining, such as under the MDE loading condition, the internal seismic force EQ must be carefully evaluated by considering the structural detailing of the tunnel lining (segments as well as segmental joints) and if necessary inelastic displacement-based structural analysis should be conducted to ensure the tunnel lining has adequate strength and ductility to accommodate the seismic ovaling deformation ΔD_{EQ} .

3B7.1.2 Numerical Modeling Approach

In using numerical modeling method to analyze bored tunnel cross-section subjected to ovaling deformation the following considerations should be included:

1. As a minimum, analyze the structure, surrounding ground, and seismic imposed deflections as a two dimensional soil-structure model (see example of a continuum soil-structure model in Figure 3B-7).

2. Include in the model, if relevant, the internal decks and walls to assess their effects on stress concentration and tunnel deformation (Figure 3B-7).
3. Model the effects of the liner joints, particularly where the joints are not properly restrained against opening and closing.
4. Accurately model the soil stratigraphy and soil properties and loads relative to the geotechnical profile and cross-section.
5. Apply the deformations due to the propagation of shear wave based on site-specific site response analyses for both the ODE and MDE. In general, the deformation analysis can be performed using pseudo-static or pseudo-dynamic analysis in which displacements or displacement time histories are statically applied to the soil-structure system. Dynamic time history analysis can also be used to further refine the analysis when necessary, particularly when some portion(s) of the tunnel structure can respond dynamically or under earthquake loading, i.e., in the case where the *inertial effect* of the tunnel structure is considered to be significant.
6. Evaluate the loads and deformation not only in the liner segments themselves but also at the joints.

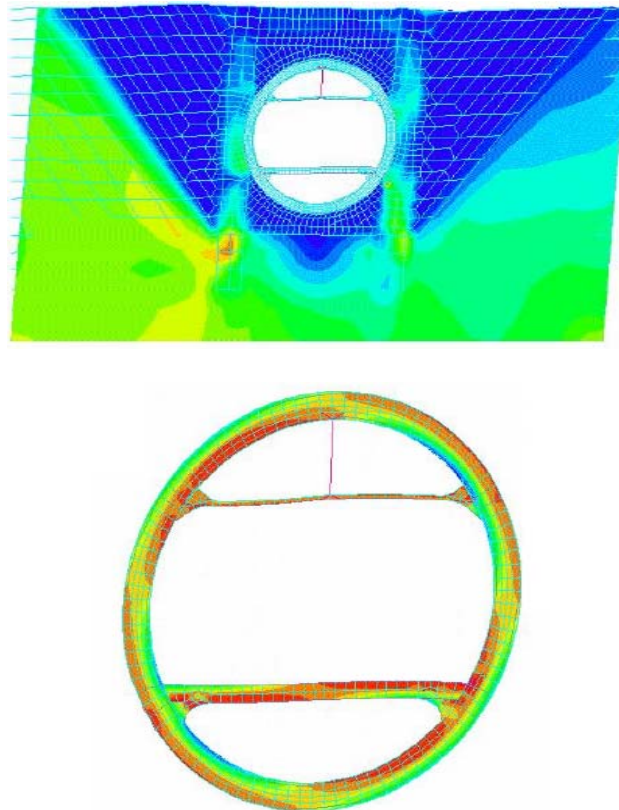

Figure 3B-7 Example of Two-dimensional Continuum Finite Element Model

3B7.2 Seismic Demands from Axial/Curvature Deformations

1. The evaluation procedures for the longitudinal response (due to axial/curvature deformations) of tunnel structures should be based on the procedures outlined in Section 13.5.2 of the Technical Manual for Design and Construction of Road Tunnels (FHWA-NHI-09-010 Report, 2009). The Free-Field Deformation procedure in section 13.5.2.1 of the Road Tunnel Manual may be used to determine the strains related to axial and longitudinal deformation of the tunnel under seismic ground motions. Supplement the analysis with Numerical Modeling Approaches similar to those in Section 13.5.2.3 of the Technical Manual where there are abrupt changes in structural stiffness or geological properties.
2. For the Free-Field Deformation analysis calculate the combined axial and bending strains from the P-Waves (pressure waves), S-Waves (shear waves), and R-Waves (Rayleigh waves) using the formulae given in Section 13.5.2.1 of the Technical Manual. The parameters associated with each class of wave are to be developed and provided by Project Geotechnical Engineers.
3. Use Numerical Modeling to investigate the effects of abrupt changes in structural stiffness or geological properties. Structural stiffness change locations can include the tunnel breakouts at the portals; where egress and ventilation shafts may joint the tunnel; and other local hard spots. Geological changes requiring numerical modeling include area of abrupt change in soil stiffness along the alignment. These include the interfaces between liquefiable and non-liquefiable soils and the interfaces between soil and rock.

3B7.3 Stability Check

1. There are two levels of stability checks for the tunnel liner design based on the performance criteria for the ODE and MDE seismic ground motions. Under the ODE there will be no to minimal damage to the lining segments, joints, and water tightness. The tunnel will be able to be put back in service after a post earthquake inspection. Under the MDE the criteria are no collapse and being able to evacuate the tunnel safely immediately after the MDE. Inelastic deformations and damage are allowed but any structural damage shall be controlled and limited to elements that are easily accessible and can be readily repaired. No collapse mechanisms are allowed.
2. Combine the seismic demands from the S-wave ovaling, axial, and curvature deformations by Square Root of the Sum of the Squares (SRSS) method.
3. Combine the seismic demands induced form the three modes of deformation during seismic shaking (i.e., ovaling, axial, and curvature deformations) with the static demand for the structure.
4. Check the section capacities relative to AASHTO LRFD as modified for tunnels in the Technical Manual for Design and Construction of Road Tunnels (Section 10.3.3).

5. Check the structure's stability relative to performance level and ductility with the following additional criteria. The concrete and steel strain limits apply to reinforced concrete lining. Where precast concrete lining are present, the concrete and steel strain limits apply to the body of the segments themselves. Separate criteria apply to the joints between the segments depending on the extent to which a ductile connection across the segments are made.
 - a. For the ODE level ground motions, design the lining to respond essentially in an elastic manner with no ductility demand. Do not exceed a concrete compression strain of 0.001. Do not exceed a steel tensile strain of 0.002.
 - b. For the MDE level design, inelastic deformations are allowed, but kept to the acceptable levels. Do not exceed a concrete compression strain of 0.002. Do not exceed a steel tensile strain of 0.006. For the MDE level design, the concrete strain may be allowed to exceed 0.002 but not to exceed 0.004 provided that the strain is predominantly in flexural mode.
 - c. For joints without being specifically designed as ductile connection, no uplift (zero tension) is allowed across the joint. Check joint shear capacity. Shear friction approach using the compressive load across the joint may be used to check the joints shear capacity. Check the joints compressive and bearing capacity relative to unreinforced concrete, unless specifically designed bearing plates and confinement is provided.
 - d. If segment joints are specifically designed as ductile connection, the concrete and steel strain limits given above may apply to the joints. Design the connection so the steel crossing the joint develops 1.25 times the yield strength of the steel without brittle failure of the concrete at the anchorages.

3B7.4 Interfaces

Interfaces between the bore tunnel and the more massive structures shall be designed as flexible/expansion joints to accommodate the differential movements. The design differential movements shall be determined by the Designer in consultation with the Project Geotechnical Engineers.

3B7.5 Geological Variations

Abrupt changes in stiffness of geologic formations shall be accommodated by designing the structures in these formations for the static and seismic loads and deformations resulting from such variations. The design parameters for these conditions will be established on a case-by-case basis by the Project Geotechnical Engineer.

The effects of abrupt changes in stiffness of geological formations are important when tunnels are in mixed face conditions, passing longitudinally from a rock formation into a soil formation or from a very stiff formation into a very soft formation. The focus in this case is on the longitudinal response of the tunnel to the differential free-field deformations between the soil (a soft formation) and the rock (a stiff formation). The most critical mode of the differential free-field deformations (along the longitudinal axis of

the tunnel) is the lateral differential deformations caused by the vertically propagating shear waves (i.e., spatially varying ground motion effects due to different site conditions).

The general procedure used for evaluating the effects of differential lateral free-field deformations on the longitudinal tunnel response in mixed face conditions due to the vertically propagating shear waves is summarized as follows:

1. Establish the free-field lateral soil and rock deformations along the tunnel alignment in the mixed face area. The free-field deformation profile along the tunnel alignment can be developed by performing multiple site-specific one-dimensional site response analyses at various locations along the tunnel alignment to account for the spatially varying ground motion effects. The site-specific analyses can be performed using site response analysis programs such as SHAKE 91 (Idriss and Sun, 1992). Refer to Section B7.1.1 for more discussions on site-specific site response analyses.
2. Derive the non-linear lateral soil or rock springs along the longitudinal alignment of the tunnel structure to represent the varying ground stiffness to be used in the mixed face area in the subsequent soil-structure interaction analysis.
3. Develop a structural model based on the properties and geometry of the tunnel structure. The articulation characteristics of tunnel circumferential joints (between two adjacent tunnel rings) may play an important role in the longitudinal seismic response of a tunnel and hence should be considered in the structural model if applicable.
4. The differential lateral free-field deformation distribution along the length of the tunnel in the mixed face area (derived from Step 1 above) is then applied to the tunnel structure model (from Step 3) through the use of equivalent soil or rock springs (from Step 2) to account for the ground-structure interaction effect.
5. The seismic demands in terms of deformations and internal forces computed from the analysis (Step 4) shall then be checked against the capacity of the tunnel structure with particular focus on the details at the circumferential joints to accommodate the required deformation and force demands.

3B8.0 REINFORCED CONCRETE BOX STRUCTURES

Reinforced concrete box structures include box (rectangular) cut-and-cover structures including passenger stations, and mined station sections that behave in similar manner as a rectangular structure during earthquake shaking. Design details for reinforced concrete box structures shall be in accordance with the provisions of the California Building Code and Caltrans implemented AASHTO LRFD. The design shall also comply with the requirements specified in Metro Rail Design Criteria Section 5 – Structural/Geotechnical.

For ODE and MDE design of reinforced concrete underground box structures use the Caltrans Seismic Design Criteria, and ACI 318 latest edition, with Metro

specified rail transit loading. These are referred to throughout these criteria as “Caltrans SDC” and “ACI”, and are to be used in conjunction with the Extreme Event I (MDE) and IA (ODE) Load Combinations per Metro Rail Design Criteria Section 5.4.7.

Commentary: Note that load factors in the Criteria for Strength load combinations are based on AASHTO and therefore member capacities which are compared with those demands should be evaluated using AASHTO methods for consistency. Load factors in the Criteria for Extreme events (ODE/MDE) are 1.0 which indicates a limit state evaluation such as per Caltrans SDC is to be performed and consequently the calculated demands are independent of the capacity methodology used. The designer should use a capacity methodology appropriate to the expected material behavior at the given demands.

Seismic design of the transverse cross section of a structure shall consider two loading components:

1. The racking deformations due to the vertically propagating shear waves, which are similar to the ovaling deformations of a circular tunnel lining (see Figure 3B-1 in Section B6.0).
2. Inertia forces due to vertical seismic motions.

3B8.1 Seismic Demands due to Racking Deformations

Two general approaches can be used to determine the seismic racking deformation of rectangular box structures.

The first approach is based on semi-closed form solution that has been calibrated with a series of numerical analyses for a number of soil-structure configurations. The semi-closed form solution is based on the following assumptions: (1) the tunnel is of rectangular shape, (2) surrounding soil is reasonably uniform, and (3) there is no interaction effect from adjacent tunnels or other structures.

The second approach is a numeric modeling approach that relies on mathematical models of the structures (including adjacent structures if relevant) to account for structural properties, varying soil stratigraphy and soil properties, loadings and deformations more rigorously. These structural models are generally run on computers with specialized software. If the actual soil-structure systems encountered in the field are more complex than the assumed conditions described above for the semi-closed form solution approach leading to unreliable results, then the use of numerical modeling approach should be adopted.

3B8.1.1 Semi-Closed Form Solution

The seismic racking loads for the lining of rectangular box structures are defined in terms of the sideway racking displacements caused by the vertically propagating shear waves of the MDE and ODE ground motions. The differential sideway racking displacement between the top and bottom elevations of a box structure is graphically shown as Δ_s in

Figure 3B-8. The internal forces and ductility demands due to the seismic racking deformation, Δ_s , can be derived by imposing the differential deformation on the structure in an elastic or inelastic frame analysis. The procedure for determining Δ_s , for both MDE and ODE level design and with the consideration of soil structure interaction effects, is as follows:

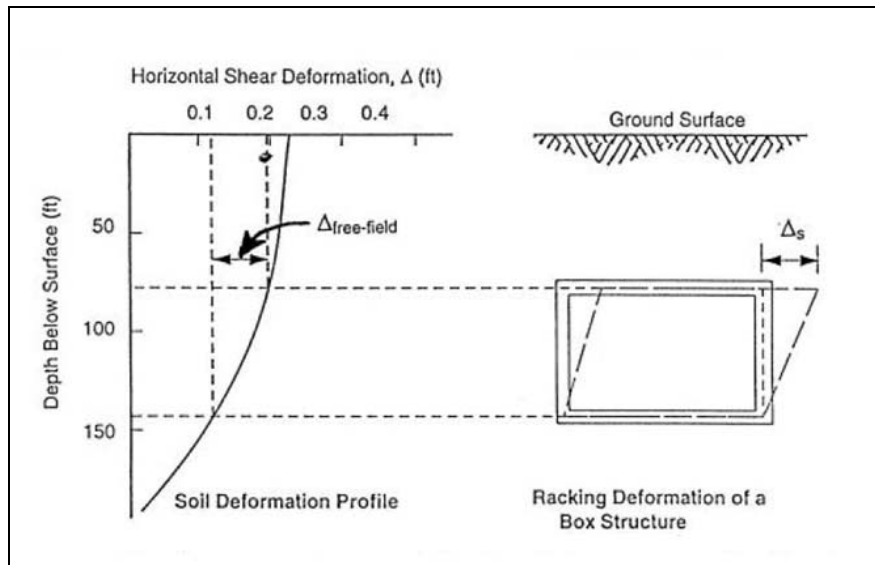

Figure 3B-8 Free-field Soil Shear Displacement Profile and Racking Deformation of a Box Structure (Wang, 1993)

1. Calculate the expected free field ground shear displacement profile caused by the vertically propagating shear waves of the design earthquakes, for both MDE and ODE (see Figure 3B-8). The development of the free-field ground shear displacement profile requires site-specific one-dimensional site response analyses using computer programs such as SHAKE 91 (Idriss and Sun, 1992). Refer to Section B7.1.1 for more discussions on site-specific site response analyses.
2. Determine $\Delta_{\text{free-field}}$, the differential free-field shear displacements corresponding to the top and the bottom elevations of the box structure (see Figure 3B-8).
3. Determine the racking stiffness, K_s , of the box structure by performing a structural frame analysis. The racking stiffness can be computed using the displacement of the roof subjected to a unit lateral force applied at the roof level, while the base of the structure is restrained against translation, but with the joints free to rotate. The ratio of the applied force to the resulting lateral displacement yields the racking stiffness K_s . In performing the structural frame analysis, the moment of inertia of the structural element I_c (for walls, floors, roof and invert slabs) per unit width shall be determined based on the expected behavior of each element under the combined seismic and static loads, accounting for cracking. The

effects of potential development of hinges shall also be considered in the frame analysis.

4. Determine the flexibility ratio, F_r , of the proposed design of the structure using the following equation:

$$F_r = (G_m / K_s) \cdot (w/h)$$

where:

K_s = racking stiffness of the box structure

w = width of the box structure

h = height of the box structure

G_m = average strain compatible shear modulus of the soil/rock layer between the top and bottom elevation of the structure. The average strain compatible shear modulus shall be derived based on the results of site-specific site response analyses

5. Based on the flexibility ratio obtained above, determine the racking ratio, R_r , for the proposed structure using Figure 3B-9, or

$$R_r = \frac{4(1 - \nu_m)F_r}{3 - 4\nu_m + F_r} \quad \text{for no-slip interface condition (between soil and structure)}$$

$$R_r = \frac{4(1 - \nu_m)F_r}{2.5 - 3\nu_m + F_r} \quad \text{for full-slip interface condition (between soil and structure)}$$

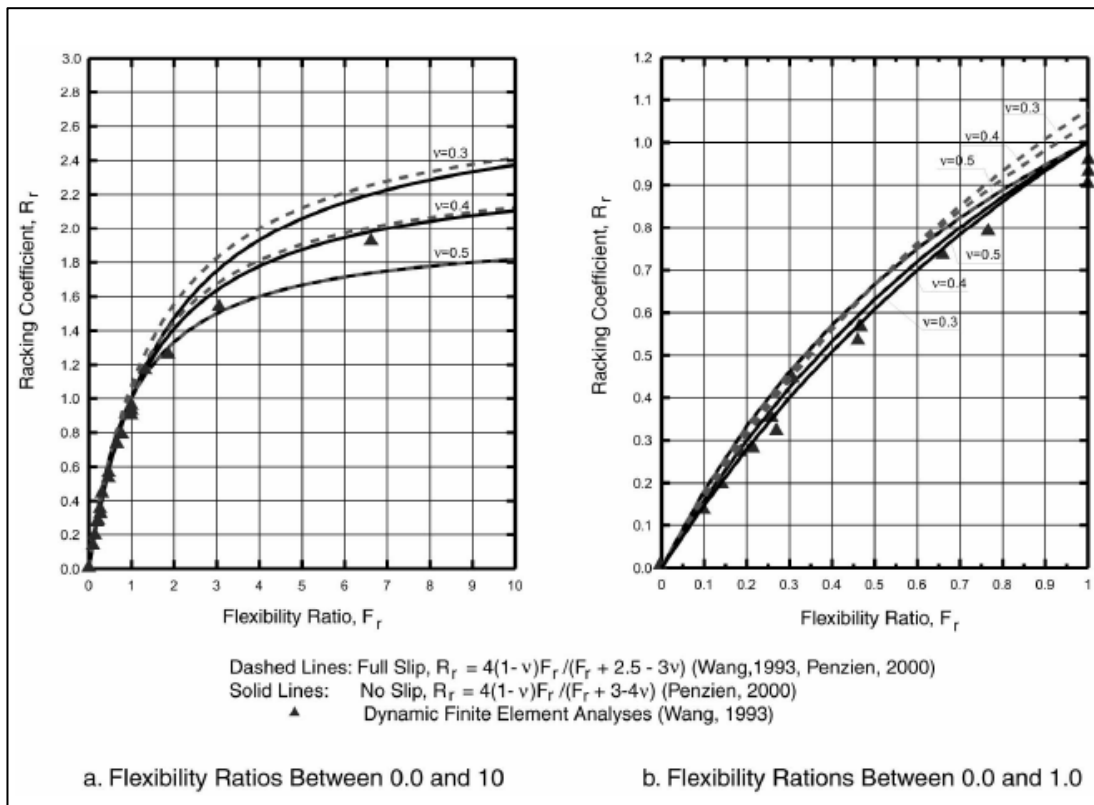

Figure 3B-9 Racking Ratio Coefficient R_r for Rectangular Box Structures (MCEER-06-SP11, Modified from Wang, 1993, and Penzien, 2000)

6. Determine the racking deformation of the rectangular box structure, Δ_s , using the following relationship:

$$\Delta_s = R_r \cdot \Delta_{\text{free-field}}$$

7. The seismic demand (due to racking deformation) in terms of internal forces as well as material strains are calculated by imposing Δ_s upon the structure in a frame analysis (elastic or inelastic) as depicted in Figure 3B-10.

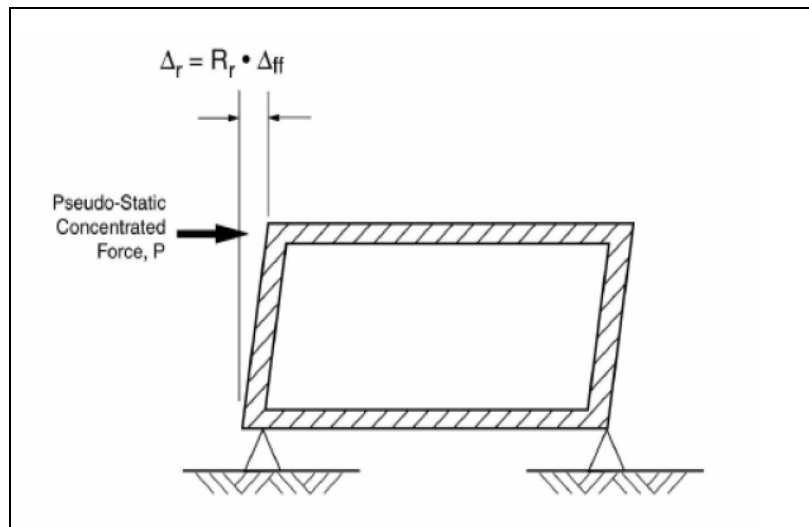

Figure 3B-10 Simplified Racking Frame Analysis of a Rectangular Box Structure (MCEER-06-SP11, Modified from Wang, 1993)

3B8.1.2 Numerical Modeling Approach

In using numerical modeling methods to analyze rectangular box structures subjected to racking deformation the following considerations should be included:

1. As a minimum, analyze the structure, surrounding ground, and seismic imposed deflections as a two dimensional soil-structure model.
2. Include in the model, if relevant, the internal floors/decks and walls to assess their effects on stress concentration and tunnel deformation.
3. Use appropriate assumption in modeling the connections between the walls and the roof or invert slabs.
4. Accurately model the soil stratigraphy and soil properties and loads relative to the geotechnical profile and cross-section.
5. Apply the deformations due to the propagation of shear wave based on site-specific site response analyses for both the ODE and MDE. In general, the deformation analysis can be performed using pseudo-static or pseudo-dynamic analysis in which displacements or displacement time histories are statically applied to the soil-structure system. Dynamic time history analysis can also be used to further refine the analysis when necessary, particularly when some portion(s) of the tunnel structure can respond dynamically or under earthquake loading, i.e., in the case where the *inertial effect* of the tunnel structure is considered to be significant. Figure 3B-11 is an example illustrating the two dimensional dynamic time history model for a cut-and cover tunnel structure.

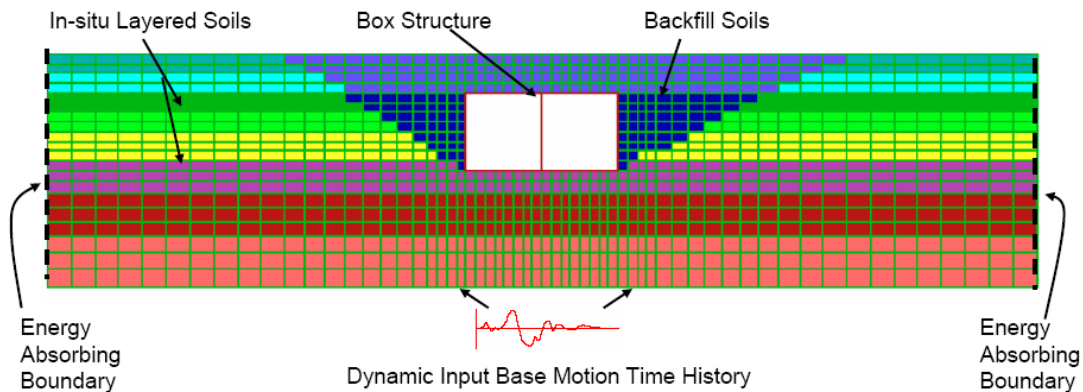

Figure 3B-11 Sample Dynamic Time History Analysis Model

3B8.2 Seismic Demands due to Vertical Ground Motions

The effect of vertical seismic motions shall be considered for rectangular box structures. For structures constructed using cut-and cover methods the effect can be accounted for by applying a vertical pseudo-static loading, equivalent to the product of the vertical seismic coefficient and the combined dead and design overburden loads used in static design. For structures constructed using mining technique, the vertical pseudo-static loading can be estimated to be the product of the vertical seismic coefficient and the combined dead load and the weight of the loosened zone above roof, which shall be determined by Project Geotechnical Engineers. The vertical seismic coefficient can be reasonably assumed to be two-thirds of the design peak horizontal acceleration divided by the gravity. This vertical pseudo-static loading shall be applied by considering both up and down direction of motions, whichever results in a more critical load case shall govern.

Seismic demands due to racking deformations and vertical seismic motions are then combined by Square Root of the Sum of the Squares (SRSS) method.

3B8.3 Stability Check

1. ~~Check the structure's stability based on the performance criteria for the ODE and MDE seismic ground motions. For the ODE level ground motions, design the lining to respond essentially in an elastic manner with no ductility demand. Do not exceed a concrete compression strain of 0.001. Do not exceed a steel tensile strain of 0.002. For the MDE level design, inelastic deformations are allowed, but kept to acceptable levels. Do not exceed a concrete compression strain of 0.002. Do not exceed a steel tensile strain of 0.006. For the MDE level design, the concrete strain may be allowed to exceed 0.002 but not to exceed 0.004 provided that the strain is predominantly in flexural mode. Segments are to act more like a column than they are a beam.~~
2. Evaluate the possible mechanisms for MDE conditions (see Figure 3B-12). Conditions with only two hinges in any one member, such as illustrated in Figure 3B-12a, are acceptable because a failure mechanism has not formed. Conditions with four hinges, such as illustrated in Figure 3B-12b, are also considered acceptable provided that the ground surrounding the structures is

stable (i.e., no liquefaction or slope instability issues) because collapse is prevented by the surrounding materials. However, formation of any of mechanisms such as 1, 2, 3, 4, or 5 in Figure 3B-12c would lead to stability problems and these mechanism are, therefore, not acceptable.

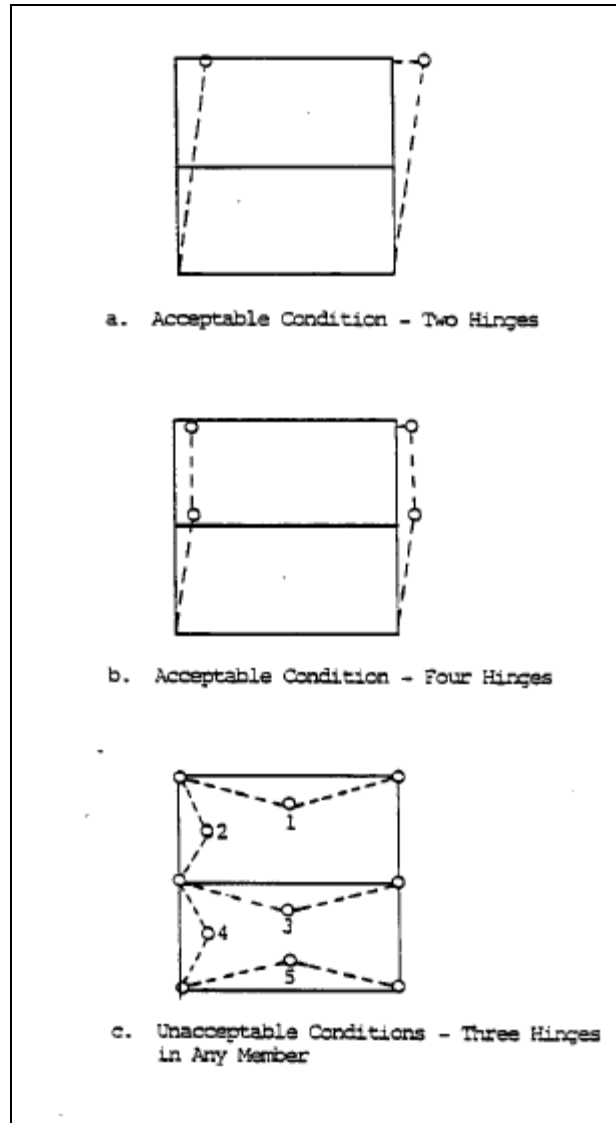

Figure 3B-12 Structure Mechanisms under MDE

3B8.4 ODE Design Approach

Member capacities shall be evaluated using LRFD resistance factors (Φ), and required demands as determined from elastic analyses shall remain at or below the design capacity of the section ($R_u \leq \Phi R_n$, which is a demand to capacity ratio $D/C \leq 1.0$).

Nonlinear methods shall be used to study soil-structure interaction and P-Delta effects. Provide special consideration to areas of discontinuity, sudden changes in loading conditions, etc.

Box structural elements shall be designed to fail in a predominantly flexural mode by requiring the design shear capacity at each end to exceed the greater of the factored shear demand determined by analysis or the force required to develop the overstrength moment of the weaker member framed into a joint. Non-ductile failure modes shall be avoided.

While limit state analyses and special detailing are not required for this level of demand, members shall still be proportioned such that the box walls will reach a limit state prior to the box roof slab, box invert slab, and box joints. Reasonable efforts shall be made to proportion members such that global failure modes are ductile.

Commentary: For ODE level ground motions, this approach may be reasonably expected to allow the box structure primary members to perform essentially in an elastic manner with no ductility demand. Elastic structural analysis models are generally adequate for evaluating Gravity and ODE demands on the box structure. Note that compression forces may not be considered in calculating the shear capacity of the roof slab and invert slab per Criteria Section 5.4.7.C. The intent of the Criteria is for the designer to use engineering judgment to consider whether the use of shear or flexural capacity increases with compression loads which may otherwise be allowed by the reference codes is conservative for the loading conditions and elements being evaluated as the codes were not expressly written for below grade concrete structures.

3B8.5 MDE Design Approach

When MDE demands are relatively low, the analysis and design may follow the approach given in section 3B8.4 for ODE with member flexural and axial capacities evaluated using the nominal capacity M_n ($\Phi = 1.0$ for bending and axial) and member shear capacities conservatively based on the design capacity ΦV_n ($\Phi \leq 0.9$ for shear).

For the MDE level design, inelastic deformations are allowed, but kept to acceptable levels. When MDE analysis indicates relatively high demands such that inelastic behavior can be expected or where elastic design is not economical the following sections shall apply.

3B8.5.1 Analysis

Elastic structural analysis models shall be considered adequate for evaluating MDE cases which generate member flexural demands less than the nominal

moment capacity based on expected material properties (M_{ne} defined per Caltrans SDC), which may be estimated as $1.1 \cdot M_n$ when subjected to axial compression loads less than $0.1 \cdot A_g \cdot f'_c$. For members subject to tension or high axial compression, this value shall be determined from a moment-curvature analysis of the section. Significant inelastic behavior is anticipated beyond M_{ne} , therefore ductility and moment redistribution must be evaluated using inelastic analysis models which account for material nonlinearity.

Inelastic modeling shall include the effects of inelastic/plastic hinge zones, with properties based on expected material properties and strains outlined in Caltrans SDC for Pier Walls loaded in their weak direction. Instead of the bilinear elastic/perfectly-plastic hinge given by Caltrans SDC, the hinge model shall include the effect of post yield stiffness prior to reaching a perfectly-plastic region.

Commentary: It is important to note that the basic Caltrans SDC procedure is based on large levels of ductility demand (drift) while the typical below grade box structure may be expected to have a performance goal with relatively low levels of ductility demand. The full plastic moment capacity of a section as calculated using the Caltrans SDC may not develop until well beyond the strain limits specified. The inclusion of a post-yield relationship in the hinge definition is therefore necessary to allow the model to capture material stress/strain distributions at demands above the expected yield point which occur before reaching the Caltrans SDC plastic moment.

For non-linear inelastic time history analyses where the application of vertical ground motion seismic demands using SRSS per Section 3B8.2 is impractical, the effects of vertical and horizontal seismic ground motion may be applied using the alternative combination $EQ = 100\% EQ_{horiz} \pm 35\% EQ_{vert}$.

3B8.5.2 Capacity Evaluation

Members designed to perform beyond a yield limit state shall be evaluated using a moment-curvature analysis program in a method consistent with Caltrans SDC to determine the approximate strain distribution in the concrete and reinforcement components as well as the member ductility for inelastic demand. The design shall consider the effects of both L_p per Caltrans SDC Section 7.6.2(a) as an upper bound and the lesser of $L_{p,min}$ or $h/2$ as a lower bound unless justification of a larger value can be made.

Commentary: The idealized analytical plastic hinge length L_p per the Caltrans SDC procedure is typically longer than $h/2$, and is always longer than $L_{p,min}$. At low levels of inelastic demand the length of the yielding region is expected to be shorter than L_p , and its use would result in the calculation of unconservative total curvature and strain demands (due to their inverse relationship). There is limited research on hinge lengths for low levels of deformation, the $h/2$ lower bound is per FEMA 356 and is assumed to be conservative. It is not the intent of this section to reduce the dimensions of the plastic hinge zone for reinforcement detailing purposes.

3B8.5.3 Design

The Caltrans SDC and ACI seismic design basis is such that certain portions of members will be subjected to significant inelastic deformations, with flexural demands at those regions based on the plastic moment (M_p). Adjacent members which are to remain essentially elastic are defined as “capacity protected” and shall be designed to resist an overstrength demand moment. Where it may be shown that MDE demands are less than M_p , capacity protected components may be designed for an overstrength demand of 1.2 times the maximum demand obtained by inelastic analysis ($1.2M_u$) and not less than the nominal moment capacity based on expected material properties (M_{ne}).

Commentary: The definition of M_p is different between ACI and Caltrans SDC, and may be determined per either method at the designer’s discretion. The design and detailing requirements are expected to be applied consistent with the selected method throughout, do not mix and match the two procedures. Note that Caltrans SDC is based on a premise that inelastic behavior occurs only in the vertical column/wall elements (capacity protected superstructure and foundation), while ACI is based on inelastic behavior only in beam elements (strong column/weak beam), the requirements and terminology should be translated to the appropriate box configuration and elements per the performance goals in this Criteria.

Where inelastic behavior is expected to occur in a member adjacent to a slab-wall joint at MDE, the joint shall be designed as a capacity protected component. The design shall consider the forces imposed on a corner joint based on the overstrength moment of the weaker member framed into it. This will force inelastic behavior out of the joint and into the adjacent member where damage may be more readily observed and repaired.

3B8.5.4 Performance Criteria

Commentary: Section 3B3.0 describes several performance objectives for MDE, the following criteria are provided as one approach which may reasonably be expected to achieve these performance goals. Alternative criteria may be submitted with appropriate justification for Metro approval.

Inelastic behavior shall be designed to occur in locations which are readily observable and accessible for repair. Cracking of box joints and concrete spalling at the exterior of the box may not be observable or readily repairable and should therefore be avoided. Damage to the box roof slab may cause undue concern of collapse and should also be avoided.

The box roof slab, box invert slab, and box joints shall be considered capacity protected to perform as essentially elastic with MDE demands. Box walls, interior floor slabs and columns shall be designed and detailed for ductile behavior to accommodate inelastic hinging, with a minimum local displacement ductility capacity of $\mu_C \geq 4$ as calculated per Caltrans SDC. MDE global displacement ductility demand μ_D on the inelastic cross section should be less than 4.

Commentary: The global displacement ductility demand is calculated per Caltrans SDC by dividing the ultimate displacement by the initial displacement at which the first hinge forms. Note that high gravity induced flexural demands at box joints may cause inelastic behavior during seismic racking to form quickly

under low displacement. This will result in higher (more conservative) ductility demand values than for a similar above-ground structure designed per Caltrans SDC, therefore the given performance ductility demand is to be used as a guideline only. Ductility demands exceeding this value may indicate yielding behavior occurs at low levels of seismic demand and implies greater risk of damage.

Members subject to MDE demands which exceed their nominal flexural capacity as calculated using expected material properties (M_{ne}), shall have plastic rotation and axial demands determined by inelastic nonlinear analysis. Material strains shall then be evaluated at the plastic rotation and axial demands by using a nonlinear moment-curvature fiber section analysis.

The following strain limits are provided for control of damage where inelastic behavior is allowed:

Continuous elements with seismic cross-tie confinement:

Maximum steel reinforcement strain for reparability: 0.02

Maximum concrete strain at extreme fiber for reparability: 0.0033

Elements adjacent to discontinuities with seismic hoop confinement:

Maximum steel reinforcement strain for reparability: 0.025

Maximum concrete strain at extreme fiber for reparability: 0.004

Commentary: The reinforcement strain limit is intended to allow minimal to moderate amount of inelastic deformation of the steel reinforcement while avoiding bar buckling and fatigue failure. The concrete strain limit for continuous elements is intended to provide a reasonable control against extensive spalling of the cover and is based on two-thirds the ultimate unconfined concrete strain per Caltrans SDC. Note that concrete strain does not need to be checked for the confined portion since the strain limit at the extreme fiber (cover) will control. It is recognized that elements adjacent to openings in the box will be subject to higher demands with a corresponding increased risk of damage, however it should be confined to localized regions.

3B8.6 Detailing

Detailing of the box walls, floor and roof for inelastic behavior at MDE (D/C ratio exceeds 1.0) shall be per ACI 318 Chapter 21 and as modified by this Criteria. A minimum of two layers of reinforcement shall be used. Sufficient cross-ties shall be provided to prevent longitudinal bar buckling and comply with the confinement requirements in plastic hinge zones and joints. Cross ties in plastic hinge zones and joints shall not be smaller than #4 bars and spaced no greater than 6 inches on center along longitudinal reinforcement and 12 inches on center along the transverse direction. Cross ties shall directly engage the perimeter longitudinal bars and the location of the 135 degree hook shall be alternated at each tie along the longitudinal bar direction. Cross ties shall be considered adequate for confinement of continuous walls or slabs, hoops shall be used adjacent to areas of high local demand. Special consideration is to be given to locations where

these elements experience high axial loads, net tension, or areas at discontinuities and openings. Reinforcement splices, development lengths and details shall be based on ACI 318 or AASHTO LRFD using the appropriate requirements according to the strain and ductility demands determined by analysis.

Commentary: The detailing of an underground box for inelastic behavior is not well defined in current codes, and therefore some interpretation is required to meet the intent of the ACI or Caltrans SDC for this type of structure. The tie spacing and size indicated above are not intended to supersede code requirements which are likely to be more stringent. The designer may look to the requirements in ACI for special concrete moment frames, especially one-sided roof beam to column joints, and in Caltrans for Pier walls loaded out of plane or bridge knee joints. For additional information the designer may also refer to "Caltrans Memo To Designers 6-5" for recommendations of detailing lightly loaded pier walls for inelastic ductility. Also see requirements in Criteria Sections 5.4 and 5.4.12.2. It is desirable to place temperature reinforcement towards the exterior faces of the wall to aid in restraining primary reinforcement buckling and limit cover spalling, however this must be balanced with constructability issues.

3B9.0 VERTICAL SHAFT STRUCTURES

The primary seismic considerations for the design of vertical shaft structures are the curvature strains and shear forces of the lining resulting from ground shear strains due to vertically propagating shear waves. Force and deformation demands are particularly critical in cases where shafts are embedded in deep, soft deposits or cross boundary between two geological strata with stark contrast in stiffness. The general procedure used for evaluating the effects of ground shear strains on shaft structures due to the vertically propagating shear waves is summarized below:

1. Establish the free-field soil/rock shear deformation profile similar to the one shown in Figure 3B-8, for both MDE and ODE. This shear deformation profile is the result of ground shear strains due to shear waves propagating vertically from the base rock (or very firm base stratum) to the ground surface and shall be estimated by performing free-field site-specific site response analyses using computer program such as SHAKE 91 (Idriss and Sun, 1992). The analyses should account for the various stiffness and damping values (strain dependent) of the various soil and rock layers at the shaft site (refer to discussions in B7.1.1). The analyses should extend from the base firm stratum or the bottom of the shaft, whichever is deeper, to the ground surface.
2. Derive the non-linear springs along the vertical alignment of the shaft structure to represent the varying ground stiffness and strength to be used in the subsequent soil-structure interaction analysis. The non-linear springs should be derived by using the strain-compatible shear modulus obtained from the site-response analyses and considering the diameter/width of the shaft, as well as the discretization of the shaft structure in the structural analysis model.
3. Develop structural models based on the properties and geometry of the shaft structures.

4. The relative lateral shear deformation profile (derived from Step 1 above) between the top (usually the ground surface) and the bottom of the shaft is then applied to the shaft structure model (from Step 3) through the use of equivalent soil/rock springs (from Step 2) to account for the soil-structure interaction effect. In the analysis, the relative shear deformation is used as the prescribed displacement at the support end of each soil/rock spring.
5. The seismic demands in terms of internal forces (e.g., shear and bending forces) and material strains are computed from the analysis (Step 4) and shall then be combined with non-seismic loads for design and evaluation purposes

3B10.0 LATERAL LOADING FROM NEW OR EXISTING BUILDINGS

Where direct interaction between surface buildings and underground structures occurs, the effects of surface buildings on underground structures, expressed in terms of base shears and/or rocking moments, shall be added to the ground deformation effects on underground structures.

In cases where buildings and underground structures are separated by earth materials, the additional lateral earth pressure due to the inertial forces transmitted from the building through the earth to the underground structures shall be determined and added to the ground deformation effects on the underground structures.

3B11.0 RETAINING WALLS AND U-SECTIONS

For conventional reinforced concrete retaining walls and U-walls, seismic loads expressed in terms of dynamic earth pressures, as outlined in NCHRP Report No. 611, *“Seismic Analysis and Design of Retaining Walls, Buried Structures, Slopes, and Embankment”*, (2008 Transportation Research Board), shall be followed. Special considerations shall be directed to the yielding/non-yielding nature of the walls in determining the dynamic earth pressures. For retaining walls that are allowed to accommodate some limited deformations, depending on their functioning requirements during MDE and ODE, the dynamic earth pressures may be reduced by selecting a design seismic coefficient lower than the peak ground acceleration value (expressed in terms of percent gravity, g). For U-walls, permanent sliding displacement is not likely to occur and therefore the dynamic earth pressures shall be derived based on the non-reduced peak ground acceleration value **or the numerical modeling approach similar to that as presented in Section 3B8.1.2.**

3B12.0 EFFECTS OF FAULT RUPTURE

The general design philosophy for a tunnel crossing seismically active faults is to accept and accommodate the displacements by either employing an oversized excavation, if appropriate, backfilled with compressible/collapsible material, or using ductile lining to minimize the instability potential of the lining. In cases where the magnitude of the fault displacement is limited or the width of the sheared fault zone is considerable such that the displacement is dissipated gradually over a distance, design of a strong lining to resist the displacement may be technically feasible. The structures, however, will be subject to large axial, shear and bending forces. The analysis and design must consider many important factors including, but not limited to, the stiffness of the lining and the

ground, the angle of the fault plane intersecting the tunnel, the width of the fault, and the magnitude and orientation of the fault movement.

Analytical procedures generally used for evaluating the effects of fault displacement on lining response include structural finite-element and ground spring model and continuum soil-structure finite-element or finite-difference methods. The general procedure is summarized as follows:

1. Characterize the free-field fault displacements (i.e., displacements in the absence of the tunnel) where the fault zone crosses the tunnel, per procedure outlined in Section 2.4 (- Surface Fault Rupture Displacement) of the Metro SSDC.
2. Characterize the soil or rock behavior and derive the corresponding parameters along the longitudinal alignment of the tunnel structure to represent the varying non-linear ground stiffness and strength of the surrounding ground within as well outside the fault zone area. If the structural finite-element and ground spring model is considered appropriate and used in the analysis, then develop the nonlinear transverse and axial (frictional) ground springs to be connected to the tunnel (to model soil normal pressures on the tunnel lining or walls and axial frictional resistance along the tunnel alignment (Figures 3B-13 and 3B-14). If the continuum soil-structure finite-element or finite-difference methods are adopted, then develop proper constitutive material laws and corresponding parameters for the surrounding ground to be incorporated in the continuum soil-structure finite-element or finite-difference models.
3. Develop a structural model based on the properties and geometry of the tunnel structure. The non-linear inelastic characteristics of tunnel lining (including the presence of joints and potential hinges) may play an important role in the longitudinal seismic response of a tunnel and hence should be considered in the structural model if applicable.
4. The free-field fault displacement distribution along the length of the tunnel in the fault crossing area (derived from Step 1 above) is then applied to the tunnel structure model (from Step 3) through the use of the non-linear ground springs (from Step 2) in the structural finite-element and ground spring model to account for the ground-structure interaction effect (Figure 3B-13). If the continuum soil-structure finite-element or finite-difference methods are adopted, then the free-field fault displacement distribution is imposed to the tunnel structure in the continuum soil-structure model through appropriate boundary conditions in the model.
5. The seismic demands in terms of deformations and internal forces computed from the analysis (Step 4) shall then be checked against the capacity of the tunnel structure.

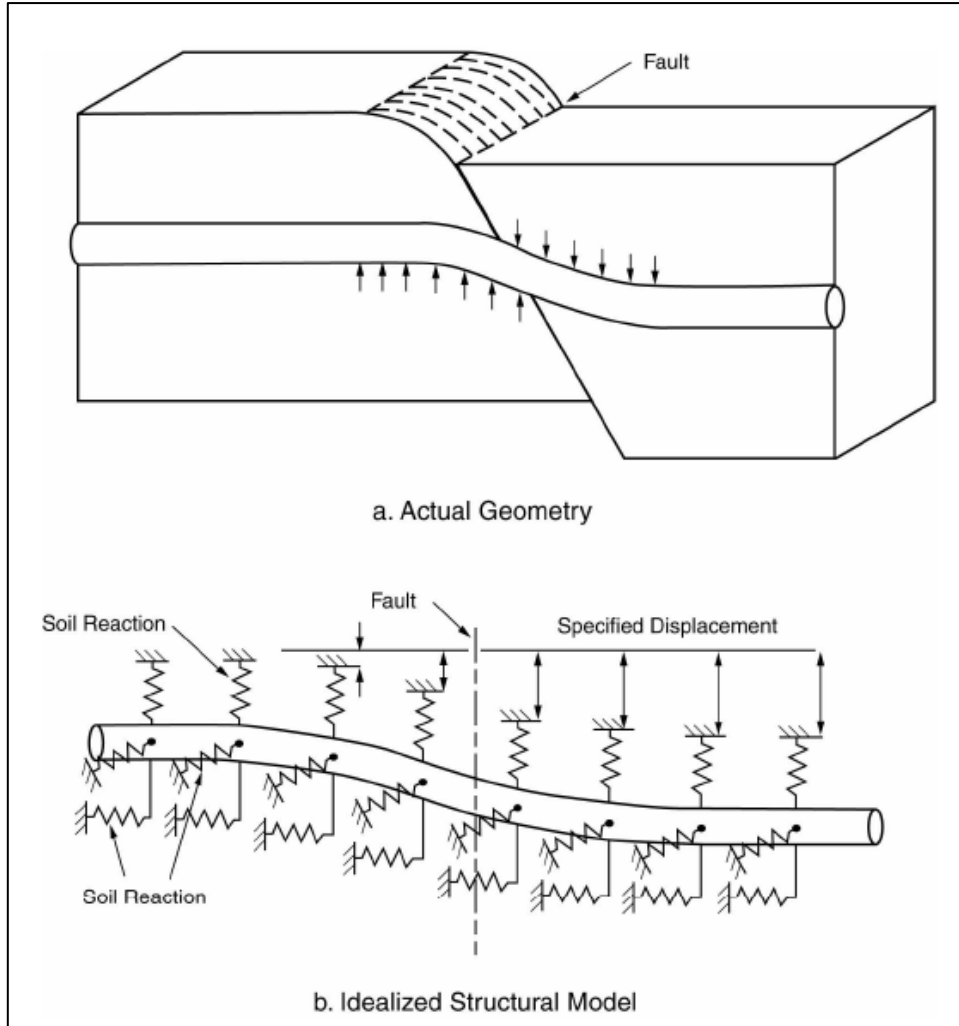

**Figure 3B-13 Tunnel-Ground Interaction Model at Fault Crossing
 (ASCE Committee on Gas and Liquid Fuel Lifelines, 1984)**

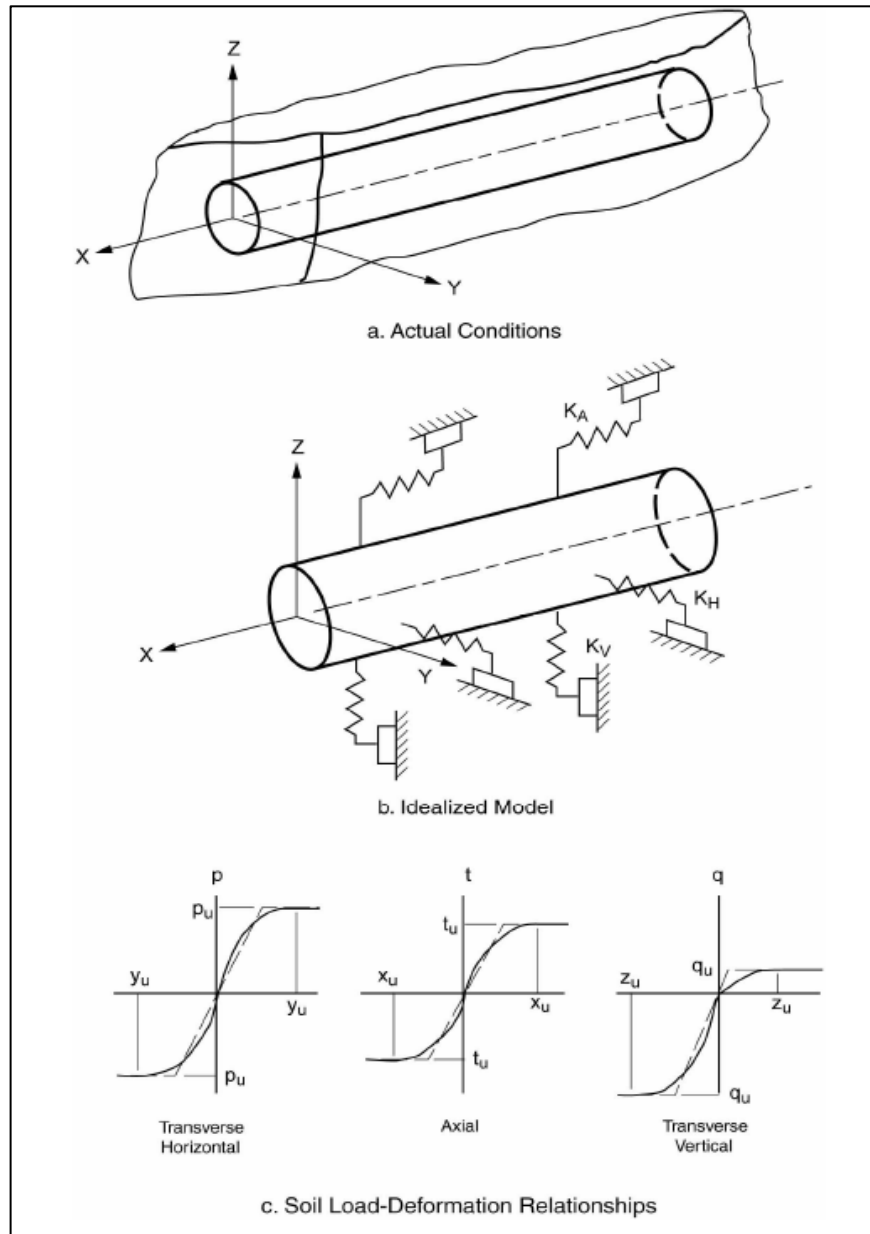

Figure 3B-14 Analytical Model of Ground Restraint for Tunnel at Fault Crossing (ASCE Committee on Gas and Liquid Fuel Lifelines, 1984)

3B13.0 SEISMIC DESIGN FOR EFFECTS OF GROUND INSTABILITY

The effects of seismically induced ground instability and permanent deformation of sloping ground or embankments on underground structures shall be considered in the design. For evaluations of slope and embankment stability, including the resulting permanent ground deformations, apply the National Cooperative Highway Research Program Report 611, Seismic Analysis and Design of Retaining Walls, Buried Structures, Slopes, and Embankments, latest edition.

3B13.1 General

The stability of the ground surrounding the underground structures along the alignment shall be considered in the design. The surrounding ground includes natural and backfill earth mass located with a zone that may influence the performance of underground structures during and after earthquakes. Ground instability as a result of seismic shaking can include liquefaction, post-liquefaction settlements, and slope/embankment instability (landslide)

3B13.2 Effects of Liquefaction and Permanent Ground Deformations

The effects of liquefaction and liquefaction-induced ground deformations shall be evaluated at relevant locations along the project alignment including tunnels, the shafts, the stations, and potential slope instability affecting the structures. These shall include the following:

- Uplift, buoyancy, and flotation of the tunnels, stations, and other underground structures;
- Post-liquefaction settlements and deformations (total as well as differential);
- Lateral sliding stability of the tunnels and other underground structures;
- Loss of bearing capacity, if applicable;
- Down-drag and reduction in lateral/vertical resistance of deep foundations supporting the underground structure, if applicable.

For soil layers in which the safety margin against initial liquefaction (triggering) is unsatisfactory, a liquefaction impact analysis based primarily on a deformation approach shall be performed. Potential impacts of liquefaction include tunnel floatation, uplift pressure, increased lateral earth pressure, down-drag force, bearing capacity failure, loss of lateral support (for piles or other deep foundations), lateral spread and slope stability problems, and post-liquefaction settlements and differential settlements. Relatively dense soils that liquefy may subsequently harden or stabilize at small deformations (cyclic mobility) and thus have relatively small impact on structures. Conversely, relatively loose soils that liquefy tend to result in much larger post-liquefaction deformations.

For underground structures, the depth of liquefaction investigation shall extend to a depth that is a minimum of 80 feet below the existing ground surface of final grade, whichever is deeper.

The proposed structures shall be designed to accommodate not only the total ground deformations but also the differential deformations. The minimum differential ground settlements to be used in the design shall be one-half of the total settlement at sites where natural soils underlie the structures. When the subsurface condition varies significantly in lateral directions and/or the soils are of Holocene deposits and/or artificial fills a minimum value of greater than one-half of the total settlement shall be used as the differential settlements.

The maximum deformation due to the differential tunnel movement (combined non-seismic and seismic movements) shall not cause long term leakage of the tunnel structures, including at its interface connections to other structures.

3B13.3 Effects of Landslide and Slope Stability

The potential for seismically induced landslides and slope instability shall be identified along the proposed alignment. If quasi-static seismic stability analysis is performed for permanent structure, the seismic coefficient shall be determined in accordance with the NCHRP Reports, "Seismic Analysis and Design of Retaining Walls, Buried Structures, slopes, and Embankment, (TRB 2008, NCHRP 2008).

For quasi-static slope stability analysis, the factor of safety shall not be less than 1.1. If the computed factor of safety is less than 1.1, an impact study shall be performed based on earthquake-induced slope movements, using a refined and more accurate method of analysis such as the Newmark Time-History Analysis or dynamic non-linear soil continuum method of analysis to estimate the movements. The Newmark Time-History Analysis is described in the National Cooperative Highway Research Program (NCHRP) Reports (611 and Volume 2 on Project 12-70), "Seismic Analysis and Design of Retaining Walls, Buried Structures, Slopes, and Embankments". The impact of the potential slope movements on the affected structures shall be assessed. If the impact assessments yield unacceptable performance of the structures, appropriate mitigation measures shall be incorporated into the design.

REFERENCES

1. ASCE Committee on Gas and Liquid Fuel Lifelines, "Guidelines for the Seismic Design of Oil and Gas Pipeline Systems", Technical Council on Lifeline Earthquake Engineering, ASCE, New York, 1984.
2. Idriss, I. M. and Sun, J. I., "SHAKE91 - A computer Program for Conducting equivalent Linear Seismic Response Analyses of Horizontally Layered Soil Deposits", Center for Geotechnical Modeling, Department of Civil and Environmental Engineering, University of California at Davis, 1992.
3. MCEER, "Screening Guide for Rapid Assessment of Liquefaction Hazard to Highway Bridges", by Youd, T. L., MCEER-98-0005, 1998
4. Penzien, J., "Seismically Induced Racking of Tunnel Linings", Earthquake Engineering and Structural Dynamics, pp. 683-691, 2000.
5. Power, M., et al., "Seismic Retrofit Manual for Highway Structures: Part II – Retaining Structures, Slopes, Tunnels, Culverts and Roadways", 2006, MCEER Report: MCEER-06-SP11

6. Proceedings of the MCEER Workshop on “Evaluation of Liquefaction Resistance of Soils”, National Center of Earthquake Engineering Research, Technical Report MCEER-97-0022, edited by Youd, T. L., and Idriss, I. M., 1997
7. “Seismic Analysis and Design of Retaining Walls, Buried Structures, Slopes, and Embankment”, NCHRP Report 611, 2008 Transportation Research Board.
8. “Technical Manual for Design and Construction of Road Tunnels – Civil Elements”, March 2009 (FHWA-NHI-09-010), U.S. Department of Transportation, Federal Highway Administration, National Highway Institute.
9. USGS, 2009, “Probabilistic Seismic Hazard Analysis Interactive Deaggregation”, Website (beta) @ <http://equint.cr.usgs.gov/deaggint/2008/index.php>.
10. Vucetic, M. and Dobry, R., 1991, “Effect of Soil Plasticity on Cyclic Response”, Journal of Geotechnical Engineering. ASCE, Vol. 117, No. 1, pp. 89-107.
11. Wang, J, “Seismic Design of Tunnels – A Simple State-of-the-Art Design Approach”, Parsons Brinckerhoff Monograph No. 7, 1993.
12. Transportation Research Board, “Seismic Analysis and Design of Retaining Walls, Buried Structures, Slopes and Embankments,” NCHRP Report 611, 2008.
13. NCHRP, Project 12-70, “Seismic Analysis and Design of Retaining Walls, Buried Structures, Slopes and Embankments,” Draft Final Report Volume 2, Recommended Specifications, Commentaries and Example Problems, 2008.
14. Caltrans (2009, Geotechnical Services Design Manual, Version 1.0 August 2009.
15. **State of California Department of Transportation (Caltrans) Bridge Design Specification (BDS) referenced “LRFD Bridge Design Specifications”, Fourth Edition, 2007, (Including 2008, 2010 and 2011 Interims), by the American Association of State Highway and Transportation Officials, (AASHTO).**
16. **State of California Department of Transportation (Caltrans), 2010, “Seismic Design Criteria, (SDC) Version 1.6.”**
17. **State of California Department of Transportation (Caltrans), December 8, 2010 Memorandum, “Implementation of SDC Version 1.6,” Barton Newton, Division of Engineering Services.**
18. **State of California Department of Transportation (Caltrans), February 1999 “Memo to Designers 6-5,” Richard Land, Shannon Post and Michael Barbour, Division of Engineering Services.**
19. **California Building Standards Commission, 2010, “California Building Code, California Code of Regulations, Title 24,” based on the 2009 International Building Code.**
20. **American Concrete Institute (ACI), 2008, “Building Code Requirements for Structural Concrete and Commentary,” (ACI 318, & ACI 318R).**
21. **Applied Technology Council, 1996, “Improved Seismic Design Criteria for California Bridges: Resource Document,” Publication 32-1, Redwood City, California.**

22. **Federal Emergency Management Agency (FEMA), 2000, “Prestandard and Commentary for the Seismic Rehabilitation of Buildings,” (FEMA 356), by the American Society of Civil Engineers.**

**END OF SECTION 5 APPENDIX
METRO SUPPLEMENTAL SEISMIC DESIGN CRITERIA**



K.3

Technical Memorandum, Geology and Soils



Inglewood Transit Connector Technical Memorandum Geology and Soils

1. INTRODUCTION

Geosyntec Consultants, Inc. (Geosyntec) understands that the City of Inglewood (City) is planning the development of an automated people mover (APM) system (approximately 1.8-mile-long) connecting the Los Angeles Metro Crenshaw/LAX light-rail line to the mixed-use development at Los Angeles Stadium and Entertainment District at Hollywood Park (LASED) via the Market Street and Manchester Blvd in the City of Inglewood (referred as Project). The Project includes rail alignment and associated five Interconnector Stations (ICS), and five Intermodal Transit Facilities (ITF)/Maintenance and Storage Facilities (MSF). Geosyntec has examined potential impacts to the proposed Project related to geology, soils, and seismicity and provides a summary of our findings in this Geology and Soils Technical Memorandum (Report). Impacts examined in this Report include risks related to geologic hazards such as earthquakes, landslides liquefaction, and expansive soils. This Report also includes a description of the regulatory framework, significance criteria, and impact analysis related to the Project.

2. PROJECT DESCRIPTION

The proposed rail alignment and the ICS will be located within the public right-of-way (ROW) along the South Market Street (starting at Market Street North Connection with the Metro Crenshaw Line), West Manchester Boulevard, and North Prairie Avenue (terminates at West Century Boulevard at the LASED as shown in Figure 1). The entire rail alignment and the ICS are expected to be elevated. In addition, five sites (Site 1 through Site 5) along the alignment are currently proposed for the use as ITF and MSF as also shown in Figure 1. The area encompassing the rail alignment (including ICS) and the five sites proposed for the use of ITF and MSF are collectively referred as Project Site.

3. ENVIRONMENTAL SETTING

Our knowledge of the Project Site conditions has been developed from a review of the area geology, historical information, and the referenced reports prepared by others within the Project Site vicinity. The following summarizes the regional geology, Project Site conditions, seismic setting, and the regulatory framework pertinent to geotechnical issues that may impact the Project.

3.1 Topography

The Project alignment is situated within the central portion of the City, located approximately 1.75-miles northeast of the I-105 and I-405 intersection. The proposed alignment extends along existing paved roads and adjacent to residential neighborhoods, schools, commercial and retail businesses, paved parking lots, and undeveloped lots. The Project area is relatively flat-lying, sloping gently

to the south from an elevation of approximately +150 feet Mean Sea Level (ft MSL), near the Market Street North/Metro Crenshaw Line connection, to approximately +90 ft MSL at the southern extension of the Project [Dibblee and Minch, 2007].

3.2 Regional Geology

The Project Site is located within the central portion of the Los Angeles Basin, south of the Santa Monica Mountains, near the intersection of the Peninsular Ranges and Transverse Ranges geomorphic provinces of southern California. The Peninsular Ranges province is characterized by a series of northwest trending mountains and valleys separated by faults associated with, and subparallel to, the San Andreas Fault system. These rocks were intruded by Cretaceous-age (65 million years ago [mya]) granitic basement rocks, also known as the Peninsular Ranges Batholith. The Transverse Ranges are characterized by east-west trending structural features such as the Santa Monica Mountains and the Santa Monica and Hollywood faults. The Santa Monica and Hollywood faults are considered the boundary between these two physiographic provinces.

The Los Angeles Basin is a northwest-trending alluviated lowland plane filled with thick deposits of relatively unconsolidated marine and non-marine sediments bounded by the Santa Monica Mountains to the north, the Elysian, Repetto and Puente Hills to the east, the Santa Ana Mountains and San Joaquin Hills to the south and southeast, and the Pacific Ocean to the west. The relatively flat surface of the Los Angeles Basin slopes gently south, and is interrupted by locally trending northwest alignment of low hills and mesas to the south and west that extend from Newport Beach northwest to Beverly Hills, and the Palos Verdes peninsula at the southwest extremity.

The Los Angeles Basin began forming during the Late Miocene (approximately 7.2 mya) as a result of subsidence following compressional stresses between the right-oblique Whittier and Palos Verdes fault zones, and the left-oblique Santa Monica fault system [Wright, 1991]. Sedimentary deposits within the Los Angeles Basin are estimated to range in thickness from approximately 32,000 feet to 35,000 feet within the general vicinity of the Project Site [Yerkes et al., 1965].

3.2.1 Subsurface Conditions

The Project Site subsurface conditions were observed and documented during previous geotechnical investigations performed by others within the vicinity of the Project [Geocon, 2015 and SALEM, 2016]. These explorations along with published geologic maps [Dibblee and Minch, 2007 and Saucedo et al., 2016] indicate that recent Pleistocene-age alluvium forms the surficial cover within the Project Site vicinity, often with thin localized layers of artificial fill associated with previous development activities. The anticipated geologic materials below the Project corridor are described in the following sections.

Artificial Fill

Artificial fill (af) was encountered during previous investigations within the Project Site vicinity extending up to 2 feet below ground surface (ft bgs) [Geocon, 2015] and generally consisted of brown to dark brown sandy silt and characterized as slightly moist and soft to medium stiff.

Potential fill underlying the Project alignment is likely the result of grading or construction activities associated with previous development and may vary in composition and thickness.

Alluvial Fan Deposits

As described above, geologic maps of the area (Figure 2) describe relatively small portions of the Project Site area as underlain by late Pleistocene-age alluvial fan sediments of granitic sand [Dibblee and Minch, 2007]. These alluvial fan deposits (Qae) typically consist of unconsolidated to weakly consolidated sands, silts, clays, and/or mixtures thereof (sandy silts, silty sands, etc.). These materials are generally derived from material shed off the nearby Santa Monica Mountains. The thickness of the alluvial fan deposits is likely variable along the Project alignment.

Older Alluvium

Most of the Project Site is underlain by relatively older late Pleistocene-age alluvium (Qoa). The older alluvial deposits consist of sediments that were mainly shed from the Santa Monica Mountains to the north. Composition of the older alluvial deposits primarily consists of slightly consolidated deposits of silts, clays, sands, and sandy gravel, and/or mixtures thereof (e.g., sandy silts and silty sands). Similar to the alluvial fan deposits, thickness of the older alluvium materials is likely to vary along the Project alignment, but extend to depths below anticipated development associated with the proposed Project.

3.3 Seismic Setting

The tectonic setting of the Los Angeles Basin area is dominated by right-lateral strike-slip faults with a general northwest by southeast trend as a result of the interaction between the Pacific and North American lithospheric plates. Numerous faults in southern California include “active”, “potentially active”, and “inactive” faults. Division of these major groups are based on criteria by the California Geologic Survey (CGS, formerly known as California Division of Mines and Geology, CDMG) for the Alquist-Priolo Earthquake Fault Zoning Program [Bryant and Hart, 2007]. By definition, an “active” fault is one that has had displacement within Holocene time (last 11,000 years). A “potentially active” fault has demonstrated displacement of Quaternary-age deposits (last 1.6 million years). “Inactive” faults have not exhibited displacement in the last 1.6 million years.

Faults of tectonic significance mapped in the Los Angeles region and the historical earthquake epicenters in the region are presented in Figure 3. These regional faults include the Santa Monica fault zone (SMFZ) to the north and northwest, the Newport-Inglewood fault zone (NIFZ) to the east and west, and the Cabrillo, Redondo Canyon, and Palos Verdes faults offshore to the west and southwest. Faults considered active [Bryant and Hart, 2007] and their respective distances from the Project and maximum moment magnitudes are presented in Table 1.

TABLE 1 - SIGNIFICANT SEISMIC SOURCES WITHIN 100 KM OF PROJECT

Fault or Fault Segment	Fault Type ¹	Approximate Slip Rate (mm/yr) ²	Dip Direction ³	Approximate Fault Length (km) ⁴	Approximate Closest Distance to Project (km) ⁵	Approximate Maximum Magnitude (Mw) ⁶
Newport-Inglewood (onshore)	RL	1.0	-	65	0.20	7.2
Santa Monica	O/LL, R	1.0	N	28	13	6.6
Hollywood	O/LL, R	1.0	N	17	14	6.4
Raymond	O/LL, R	1.5	N	22	21	6.8
Malibu Coast	O/LL, R	0.3	N	38	36	6.7
Redondo Canyon	R	1.0	S	12	15	6.5
Palos Verdes (Santa Monica Basin section)	RL	3.0	-	99	21	7.3
Palos Verdes (San Pedro Shelf section)	RL	3.0	-	99	21	7.3
Santa Cruz- Santa Catalina Ridge	R-RL	1.0	V	24	62	7.3
San Fernando	R	2.0	N	18	34	6.7
Sierra Madre	R	2.0	N	57	32	7.2
Verdugo	R	0.5	NE	29	22	6.9
Ventura	O/LL, R	1.0	N	20	84	6.8
San Cayetano	R	5.0	N	44	60	6.8
Simi-Santa Rosa	R	1.0	N	39	49	6.9
San Gabriel	RL	1.0	N	72	50	7.0
Whittier	RL	2.5	NE	46	31	7.0
Chino	O/RL-R	1.0	NE	28	59	6.9
Elsinore (Glen Ivy section)	RL	5.0	V	38	65	6.8
Santa Cruz Island	RL	1.0	V	69	89	7.2
Coronado Bank	RL	3.0	V	24	91	7.4
Cucamonga	R	5.0	N	28	64	7.0
San Jacinto (San Bernardino section)	RL	12.0	V	35	86	6.7
San Andreas (Mojave section)	RL	30.0	V	99	68	7.1
Cabrillo (offshore)	RL	1.0	E	10	27	6.8
East Montebello	RL	-	-	-	25	-
Oak Ridge (onshore)	R	4.0	S	49	69	7.0
Anacapa-Dume	R	3.0	N	75	39	7.5
San Diego Trough	R	-	V	-	57	-

Notes:

“-“ Unspecified

1 - RL = Right Lateral Strike-Slip Fault; LL = Left Lateral Strike-Slip Fault; O/LL = Oblique Left-Lateral Fault; R = Reverse Fault

2 - Approximate Slip Rate millimeters per year (mm/yr) obtained from CGS (2003) and USGS (2008)

3 - N = North; S = South, V = Vertical, NE = Northeast, E = East

4 - Fault Length obtained from CGS (2003) and USGS (2008)

5 - Distances from Project noted are the closest distances to the surface trace or inferred projection of the fault as measured from the CDMG (1998), CGS (2003), or USGS (2008)

6 - Maximum Earthquake values reported at maximum moment magnitude by the CGS (2003) and USGS (2008)

3.3.1 Active Faults

Faults closest to the Project area that are considered “active” [Bryant and Hart, 2007] include the following:

- The Los Angeles Basin section of the NIFZ is the closest major active fault zone to the Project, with the Inglewood and Potrero fault segments located respectively at their nearest points, approximately 0.45-miles (0.75 km) east and 0.15-miles (0.25 km) west of the Project alignment (Figure 2). The NIFZ is composed of a series of discontinuous northwest trending en echelon faults extending from Ballona Gap southeast to the area offshore of Newport Beach. This zone is reflected at the surface by a line of geomorphically young anticlinal hills and mesas formed by the folding and faulting of a thick sequence of Pleistocene-age sediments and Tertiary-age sedimentary rocks [Barrows, 1974]. Historical seismic activity (between 1977 and 1985) shows mostly strike-slip faulting with some reverse faulting along the northern segment (north of Dominguez Hills), and normal faulting along the southern segment (south of Dominguez Hills to Newport Beach) [Hauksson, 1987].
- The SMFZ is considered a continuous zone comprised of five fault segments including the Malibu Coast, Santa Monica, Hollywood, and Raymond faults, with a total length of approximately 150-miles [Dolan and Rockwell, 2000]. The SMFZ exhibits both reverse and left-lateral components of slip and is located approximately 7-miles (12 km) northwest of the Project Site (Figure 3). The SMFZ extends 25-miles from the western edge of Beverly Hills across West Los Angeles and Santa Monica to Pacific Palisades, where it trends offshore and parallels the Malibu coast near Point Dume. The SMFZ extends eastward as the Hollywood fault along the base of the Santa Monica Mountains from the West Beverly Hills Lineament in the West Hollywood-Beverly Hills area, to the Los Feliz area of Los Angeles. Although the Santa Monica and Hollywood faults are considered active, these segments have not yet been included in a State of California Special Studies Alquist-Priolo Earthquake Fault Zone (A-P Zone). The active Hollywood fault trends east-west along the southern boundary of the Santa Monica Mountains, located approximately 8.5-miles (13.5 km) north of the Project Site (Figure 3).

Other significant regional faults considered “active” which have a potential for producing large magnitude (stronger shaking) events, but lie farther away from the Project area include:

- The San Andreas strike-slip fault is located approximately 40-miles (65 km) to the northeast, along the northern edge of the San Gabriel Mountains at their contact with the Mojave Desert (Figure 3). The approximately 700-mile-long San Andreas Fault is a network of faults that collectively accommodates the majority of relative north-south motion between the North American and Pacific tectonic plates [Bryant and Matthew, 2002]. The most recent movement on the fault is estimated to be Latest Quaternary (less than 15,000 ybp) with a slip rate of 30 millimeters per year (mm/yr) [CGS, 2003] and a 100-135 year recurrence rate.

- The Whittier section of the right-lateral Elsinore fault zone is approximately 17-miles (27 km) to the east of the Project (Figure 3). The most recent movement in the fault zone is estimated to be within late Quaternary (less than 15,000 ybp) with a slip rate of 2.5 mm/yr [CGS, 2003].

3.3.2 Blind Thrust Faults

Blind thrust fault zones are considered active features that do not rupture at the ground surface. Although these features present risk by generating intense seismic shaking, their respective distances to the Project are not included in Table 1 due to the uncertainty in their vertical surface projection. Known blind thrust faults within the Project Site vicinity along with their respective slip rates and maximum moment magnitudes are described below.

3.3.2.1 Elysian Park Thrust

The Elysian Park Thrust, previously defined as the Elysian Park Fold and Thrust Belt [Hauksson, 1990], is a blind thrust fault that overlies the Los Angeles and Santa Fe Springs segments of the Puente Hills Thrust [Oskin et al., 2000 and Shaw et al., 2002]. The eastern edge of the Elysian Park Thrust is defined by the northwest-trending Whittier fault zone. The closest edge of the vertical surface projection of the Elysian Park Thrust is approximately 6-miles (10 km) northeast of the Project Site. Like other blind thrust faults in the Los Angeles area, the Elysian Park Thrust is not exposed at the surface and does not present a potential surface rupture hazard; however, should be considered an active feature capable of generating future earthquakes. An average slip rate of 1.3 mm/yr and a maximum moment magnitude (**M**, defined as a measurement of the size of an earthquake in terms of energy released) **M** 6.4 were estimated for the Elysian Park Thrust [CGS, 2003].

3.3.2.2 Compton-Los Alamitos Thrust

The Compton-Los Alamitos Thrust is an inferred blind thrust fault located within the south-central portion of the Los Angeles Basin. The closest edge of the vertical surface projection of the buried thrust fault is located approximately 8-miles (13 km) southwest of the Project Site. Like other blind thrust faults in the Los Angeles Area, the Compton-Los Alamitos Thrust is not exposed at the surface and does not present a potential surface rupture hazard; however, should be considered an active feature capable of generating future earthquakes. An average slip rate of 1.5 mm/yr and a maximum moment magnitude **M** 6.8 were estimated for the Compton-Los Alamitos Thrust [CGS, 2003].

3.3.2.3 Puente Hills Blind Thrust

The Puente Hills Blind Thrust fault (PHBT) system extends eastward from downtown Los Angeles to Brea in northern Orange County. The PHBT is comprised of three north-dipping segments overlain by folds expressed at the surface as the Coyote Hills, Santa Fe Springs Anticline, and the Montebello Hills. The PHBT exhibits an estimated average slip rate of 0.7 mm/year [CGS, 2003]. Postulated earthquake scenarios for the PHBT include a single segment rupture of a magnitude **M** 6.6, and a multiple segment rupture producing an earthquake of **M** 7.1. The PHBT is not exposed

at the ground surface and does not present a potential for surface fault rupture. However, based on deformation of late Quaternary age sediments above this fault system and the occurrence of the Whittier Narrows earthquake, the PHBT is considered an active fault capable of generating future earthquakes beneath the Los Angeles Basin.

3.3.3 Potentially Active Faults

Faults considered “potentially active” that are closest to the Project alignment include the following:

3.3.3.1 Overland Fault

The Overland fault located approximately 1.3-miles (2 km) southwest of the Project Site is considered potentially active. The Overland fault trends northwest between the Charnock fault and the Newport-Inglewood fault zone, extending from the northwest flank of the Baldwin Hills to Santa Monica Boulevard in the vicinity of Overland Avenue. However, there is no evidence that the fault has offset late Pleistocene or Holocene age alluvial deposits [County of Los Angeles, 1990] and is considered potentially active by the State Geologist [Jennings, 1994].

3.3.3.2 Charnock Fault

The potentially active Charnock fault is located approximately 3.8-miles (6 km) southwest of the Project Site. The Charnock fault trends northwest-southeast subparallel to the Newport-Inglewood fault zone and the Overland fault. No recent evidence suggests the fault has offset late Pleistocene or Holocene age alluvial deposits [County of Los Angeles, 1990] and is considered potentially active by the State Geologist [Jennings, 1994].

3.4 Surface Fault Rupture

Fault rupture hazard was evaluated to assess the exposure to people or structures to substantial adverse effects, including the risk of loss, injury, or death. The potential for fault surface rupture is generally considered to be significant along “active” faults and to a lesser degree along “potentially active” faults [CDMG, 1998]. Mapped active faults do not cross the Project Site and, therefore, fault rupture hazard is considered less than significant. No mitigation measures are required.

The Project does not lie within the boundaries of an "Earthquake Fault Zone" as defined by the State of California in the Alquist-Priolo Earthquake Zoning Act [CGS, 1999]. The closest A-P Zone to the Project Site has been established for two portions of the Newport-Inglewood fault zone located approximately 280-feet west of the alignment along North Market Street (Inglewood fault), and approximately 2,750-feet east of the alignment from the intersection of West Manchester Boulevard and Prairie Avenue (Protrero fault). Therefore, performance of a Project Site-specific fault-hazard evaluation in accordance with the Alquist-Priolo Earthquake Fault Zoning Act (Public Resources Code Sections 2621-2630) is not required.

3.5 Ground Shaking

The Project Site is situated within a seismically active region and will likely experience moderate to severe ground shaking in response to a large-magnitude earthquake occurring on a local or more distant active fault during the expected lifespan of the Project. The potential for significant seismically induced ground shaking in response to an earthquake occurring along a nearby active fault, such as the Newport-Inglewood fault zone, or a regional fault, such as the San Andreas fault zone, is relatively high within the Project Site area [CDMG, 1998].

The potential for strong seismic shaking is considered high; however, a geotechnical investigation will be undertaken by a qualified geologist as part of the site design. Therefore, impacts related to ground shaking would be less than significant.

3.6 Liquefaction

Seismically induced liquefaction is a phenomenon in which saturated soils lose a significant portion of their strength and acquire some mobility from seismic shaking or other large cyclic loading. The material types considered most susceptible to liquefaction are granular and low-plasticity fine grained soils which are saturated and loose to medium dense. A rapid increase in groundwater pressures (excess pore water pressures) causes the loss of soil strength.

Manifestations of soil liquefaction can include sand boils, surface settlements and tilting in level ground, lateral spreading, and global instability (flow slides) in areas of sloping ground. The impact of liquefaction on structures can include loss of bearing capacity, drag loads on deep foundations, liquefaction-induced total and differential settlement, and increased lateral and uplift pressures on buried structures. Other factors such as soil mineralogy, void ratio, overconsolidation ratio, and age are contributing factors to liquefaction susceptibility. In general, the older or denser a deposit, the less susceptible it is to liquefaction.

According to mapped liquefaction areas on the Inglewood Quadrangle [CGS, 1999], the City of Los Angeles Safety Element [1996], and the County of Los Angeles Seismic Safety Element [1990], the Project is not located within areas identified as having a potential for liquefaction. Additionally, based on a review of the regional geologic map and subsurface conditions reported in previous geotechnical investigations, and the absence of shallow groundwater, the Pleistocene-age sediments underlying the Project Site (generally dense silty sand and firm silty clay silts) are not considered prone to liquefaction. Therefore, the potential for liquefaction and its secondary effects are considered low and a Project Site-specific study in accordance with the Seismic Hazards Mapping Act (Public Resources Code Sections 2690-2699.6) is not required.

3.7 Slope Stability

Given the topographic setting and a review of previous geotechnical evaluations in the project vicinity, no historical landslides are known to exist at the Project Site or in an area that could potentially impact the Project. The Project Site is not located within an "Earthquake-Induced Landslide Zone" [CGS, 1999] and not identified as an area that has potential for permanent ground displacements. Therefore, the potential for landslides are concerned very low and seismic slope

instability mitigation in accordance with the Seismic Hazards Mapping Act (Public Resources Code Sections 2690-2699.6) is not required.

3.8 Flooding

The Federal Emergency Management Agency (FEMA) presents the flood hazard potential in the vicinity of the Project areas as part of their Flood Insurance Rate Maps. FEMA Map No. 06037C1780F, dated 26 September 2008 [FEMA, 2008], indicates that the Project Site is located in an un-shaded Zone X which is defined as “areas determined to be outside the 0.2% annual chance flood plain”. Due to a lack of any reservoirs up gradient from the Project Site, flooding as a result of dam failure is not considered to be a viable hazard. Based on our review of the FEMA mapping, the geologic setting, and the Project Site elevations, the potential for flooding at the site is very low.

3.9 Other Geologic Hazards

The presence of potentially expansive clayey soil was not observed in the previous explorations performed within the proximity of the Project Site [SALEM, 2016]. Given the underlying geologic conditions within the area, typically silty to sandy soils, we do not anticipate expansive soils to be encountered within the limits of the Project Site. However, if expansive soils are encountered during the proposed grading, we recommend that these materials should be removed, mixed with non-expansive soils, or segregated and stockpiled for potential use as low permeable materials during grading. It is unlikely that expansive soil will be encountered; therefore, expansive soil does not constitute a significant hazard at the Project Site if appropriate grading practices are maintained.

Other potential geologic hazards evaluated which could possibly affect the Project Site include slope instability, floods, seiches, and tsunamis. Tsunamis are seismically induced waves generated by sudden movements of the ocean bottom during submarine earthquakes, landslides or volcanic activity. Seiches are similarly generated but are oscillating waves within bodies of water such as reservoirs, lakes or bays. The Project Site is not located within the County of Los Angeles mapped tsunami run-up zone [CGS, 2009]. Similarly, potential seiche inundation would not likely exceed the extent of tsunami run up and no significant reservoirs were identified up gradient within 10-miles from the Project Site area. Based on the physiographic setting of the Project Site, the distance to the ocean or other large water bodies, and the elevation of the Project Site, it is our opinion that the potential for flooding from seismically induced seiches and tsunamis is very low.

3.10 Groundwater

Based on a review of the Seismic Hazard Zone Report for the Inglewood Quadrangle [CDMG, 1998], the highest historical groundwater level in the area is greater than 50 ft bgs. Groundwater data provided in this document were collected between the early 1900’s to the late 1990’s.

According to previous investigations in the project vicinity, groundwater was not encountered within exploratory borings drilled to depths ranging from 20 to 50 ft bgs [Geocon, 2015 and SALEM, 2016]. Based on the historically high groundwater levels in the Project Site vicinity and

absence of groundwater observed during previous investigations, groundwater is neither expected to be encountered during Project construction, nor have a detrimental effect on the Project.

4. REGULATORY FRAMEWORK

The City's General Plan Safety Element policy and current City development review practices address seismic hazards under laws such as Alquist-Priolo Earthquake Fault Zoning Act, Seismic Hazard Mapping Act, Real Estate Disclosure Requirements, CEQA, Uniform Building Code and California Building Code and Unreinforced Masonry Law. Compliance with these laws and the City's seismic design standards will be required to mitigate the structural effects of seismic shaking. The City Planning & Community Development Department will enforce the seismic design provisions for Seismic Zone 4 of the California Building Code, including near-source seismic conditions.

California Public Resources Code Sections 2621-2630, the Alquist-Priolo Earthquake Fault Zoning Act, is intended to provide policies and criteria to assist cities, counties, and state agencies in the exercise of their responsibility to prohibit the location of developments and structures for human occupancy across the trace of active faults. It is applicable to any project, as defined in Section 2621.6, which is located within a delineated earthquake fault zone. As indicated in Section 3.4, the Project Site is not situated within an Alquist-Priolo Earthquake Fault Zone, and the nearest Alquist-Priolo Earthquake Fault Zones are located along portions of the Newport-Inglewood-Rose Canyon fault zone located approximately 280-feet west of the alignment along North Market Street (Inglewood fault), and approximately 2,750-feet east of the alignment from the intersection of West Manchester Boulevard and Prairie Avenue (Protrero fault).

5. SIGNIFICANCE CRITERIA

Criteria outlined in the California Environmental Quality Act (CEQA) Guidelines were used to determine the level of significance of geology, soils, and seismicity impacts. Appendix G of state CEQA Guidelines indicates that a project would have a significant effect from these impacts if it were to:

- Expose people or structures to potential substantial adverse effects, including the risk of loss, injury, or death involving:
 - a. Rupture of a known earthquake fault, as delineated in the most recent Alquist-Priolo Earthquake Fault Zoning Map issued by the State Geologist for the area or based on other substantial evidence of a known potentially active fault (Refer to CDMG Special Publication 42 [Bryant and Hart, 2007]);
 - b. Strong seismic ground shaking;
 - c. Seismic-related ground failure, including liquefaction; and
 - d. Landslides;
- Result in substantial soil erosion or the loss of topsoil;

- Be located on a geologic unit or soil that is unstable, or that would become unstable as a result of the project, and potentially result in on- or off-site landslide, lateral spreading, subsidence, liquefaction or collapse;
- Be located on expansive soil, as defined in Table 18-1-B of the Uniform Building Code (UBC, 1994), creating substantial risks to life or property; or
- Have soils incapable of adequately supporting the use of septic tanks or alternative wastewater disposal systems where sewers are not available for the disposal of wastewater.

6. POTENTIAL IMPACTS

6.1 Expose people or structures to potential substantial adverse effects, including the risk of loss, injury or death involving:

i) Known Fault Rupture Zone

The Project Site is not located within an Alquist-Priolo “Earthquake Fault Zone”. The potential for surface rupture at the site due to faulting at the ground surface during the design life of the proposed Project is considered low. Therefore, impacts related to fault surface rupture would be less than significant.

ii) Strong Seismic Ground Shaking

Although the Project Site could be subjected to strong ground shaking in the event of an earthquake, this hazard is common in southern California and the effects of ground shaking will be limited by proper engineering design and construction in conformance with current building codes and engineering practices. Therefore, impacts related to strong seismic ground shaking would be less than significant.

iii) Seismic-Related Ground Failure, Including Liquefaction

The Project Site is not located within a “Liquefaction Zone” as shown on the Earthquake Zones of Required Investigation, Inglewood Quadrangle map [CDMG, 1998]. Therefore, impacts related to seismic related liquefaction would be less than significant.

iv) Landslides

The Project Site is not located within an “Earthquake-Induced Landslide Zone” as shown on the Earthquake Zones of Required Investigation, Inglewood Quadrangle map [CDMG, 1998]. Based on the topographic setting and a review of previous geotechnical evaluations in the Project vicinity, no historical landslides are known to exist that could potentially impact the Project and would not expose people or structures to potential hazards associated with slope-instability or landslides. Therefore, no impacts related to slope instability or landslides would occur.

6.2 Result in substantial soil erosion or the loss of topsoil

The Project Site is currently developed with existing paved roads, residential neighborhoods, office buildings and parking lots. Project construction would temporarily expose on-site soils to surface water runoff. Compliance with construction-related best management practices (BMPs) would control and minimize erosion and siltation. Appropriate erosion control BMPs may include, but are not limited to silt fencing, fiber rolls, sand bag barriers, gravel bag berms and stabilized construction site entrance/exit and any other practices laid out in the City's Low-Impact Development (LID) Standards Manual. Following construction activities, runoff would be directed into existing storm drains that receive surface water runoff under existing conditions, and runoff would not encounter unprotected soils. Because Project implementation would include standard construction BMPs outlined in a SWPPP, impacts related to soil erosion or loss of topsoil would be less than significant.

6.3 Be located on geologic unit or soil that is unstable, or that would become unstable as a result of the project, and potentially result in on- or off-site landslide, lateral spreading, subsidence, liquefaction, or collapse

Subsidence and ground collapse generally occur in areas with active groundwater withdrawal or petroleum production. The extraction of groundwater or petroleum from sedimentary source rocks can cause the permanent collapse of the pore space previously occupied by the removed fluid. The Project does not involve the creation of new groundwater wells. Subsidence and ground collapse can also occur during dewatering activities. However, dewatering is not necessary for the Project. U.S. Geological Survey (USGS) groundwater measurements indicate that groundwater in the vicinity is at least 85 feet below grade. Since the Project does not include substantial excavation or subterranean structures, groundwater would not be encountered during construction. Project design features and construction would comply with all applicable building codes and standards. With adherence to existing regulations, impacts related to geological failure, including lateral spreading, off-site landslides, liquefaction, or collapse would be less than significant.

6.4 Be located on expansive soil as defined in Table 18-1-B of the Uniform Building Code (1994), creating substantial risks to life or property

Expansive soils have relatively high clay mineral content and are usually found in areas where underlying formations contain an abundance of clay minerals. Due to high clay content, expansive soils expand with the addition of water and shrink when dried, which can cause damage to overlying structures.

The Project would incorporate standard construction practices to maintain the integrity of the Project site and proposed structures. Additionally, Project design features and construction would comply with all applicable building codes and standards. With adherence to existing regulations, impacts related to expansive soils would be less than significant.

6.5 Have soils incapable of adequately supporting the use of septic tanks or alternative waste water disposal systems where sewers are not available for the disposal of waste water?

The Project Site is located in a highly urbanized area, where wastewater infrastructure is currently in place. The Project would connect to existing sewer lines that serve the Project Site and would not use septic tanks or alternative wastewater disposal systems. Therefore, no impact would occur.

7. LIMITATIONS

The professional opinions and recommendations expressed in this Report are made in accordance with generally accepted standards of practice and were based largely on source information provided by others. No other warranty is either expressed or implied. Geosyntec is responsible for the findings contained in this Report based on the data available and information relating only to the specific Project and location discussed herein. Geosyntec is not responsible for use of the information contained in this Report for purposes other than those expressly stated in this Report, namely supporting the completion of the initial study checklist. Geosyntec is not responsible for any conclusions or recommendations made by others based upon the data or conclusions contained herein unless given the opportunity to review them and concur with them in writing.

8. REFERENCES

- Barrows, A.G., 1974. "A Review of the Geology and Earthquake history of the Newport Inglewood Structural Zone," CDMG, Special Report 114, 115 pp.
- Bryant, W.A. and Hart E.W., 2007. "Fault-Rupture Hazard Zones in California – Interim Revision 2007," CDMG, Special Publication 42.
- Bryant, W. A., and Lundberg, M. Matthew Compilers. 2002. Fault number 1h, San Andreas Fault zone, Mojave section, in Quaternary fault and fold database of the United States. U.S. Geological Survey website <http://earthquakes.usgs.gov/hazards/qfaults>. 2002.
- California Division of Mines and Geology (CDMG), 1998. "Seismic Hazard Zone Report for the Inglewood 7.5-Minute Quadrangle, Los Angeles County, California," California Department of Conservation.
- California Division of Mines and Geology (CDMG), 1999. "State of California Seismic Hazard Zones. Beverly Hills Quadrangle, Official Map," released 25 March 1999.
- California Geological Survey (CGS), 1999. "Earthquake Zones of Required Investigation – Inglewood Quadrangle," 25 March 1999.
- California Geological Survey (CGS), 2003. "California Probabilistic Seismic Hazards Appendix A 2002 California Fault Parameters", 2002 Revisions to Open File Report OFR 96-08 CGS, dated June 2003.
- California Geological Survey (CGS), 2009. "Tsunami Inundation Map for Emergency Planning State of California, County of Los Angeles, Beverly Hills Quadrangle," 1 March 2009.

- City of Inglewood (City), 1995. "City of Inglewood General Plan Safety Element." Accessed 22 June 2018: <https://www.cityofinglewood.org/DocumentCenter/View/126/Safety-Element-1995-PDF?bidId=>
- Dibblee, T.W. and Minch, J.A., 2007. "Geologic Map of the Venice and Inglewood Quadrangles, Los Angeles County, California." Dibblee Geological Foundation, Map DF-322, scale 1:24,000.
- Division of Oil, Gas, & Geothermal Resources (DOGGR), 2018. "Well Finder," State of California, Department of Conservation. Accessed 22 June 2018: <https://maps.conservation.ca.gov/doggr/wellfinder/#close>
- Dolan, J. F., Sieh, K., and Rockwell, T. K., 2000, "Late Quaternary Activity and Seismic Potential of the Santa Monica Fault System, Los Angeles, California," Geological Society of America Bulletin, Vol. 12, No. 10.
- Federal Emergency Management Agency (FEMA), 2008. "Flood Insurance Rate Maps," FEMA Map No. 06037C1780F, 26 September 2008.
- Geocon West, Inc., (Geocon), 2015. Geotechnical Investigation, Knowlton Place Homes Small Lot Subdivision, 6919 Knowlton Place, Los Angeles, California. 25 November 2015
- Hauksson, E., 1990. "Earthquakes, Faulting, and Stress in the Los Angeles Basin," Journal of Geophysical Research, Vol. 95, No. B10, pp. 15,653-15,394.
- Hauksson, E., 1987. "Seismotectonics of the Newport-Inglewood Fault Zone in the Los Angeles Basin, Southern California," Bulletin of the Seismological Society of America, Vol. 77, pp. 539-561.
- Jennings, C.W., 1994. "Fault Activity Map of California and Adjacent Areas with Locations and Ages of Recent Volcanic Eruptions," CDMG Map No. 6.
- Los Angeles, City of, 1996, "Safety Element of the General Plan."
- Los Angeles, County of, 1990, "Technical Appendix to the Safety Element of the Los Angeles County General Plan," Draft Report by Leighton and Associates with Sedway Cooke Associates.
- Oskin, M., Sieh, K., Rockwell, T., Miller, G., Guptill, P., Curtis, M., McArdle, S., and Elliot, P., 2000. "Active Parasitic Folds on the Elysian Park Anticline: Implications for Seismic Hazard in Central Los Angeles, California," Bulletin of the Geological Society of America, Vol. 112, No. 5, 693-707.
- SALEM Engineering Group, Inc. (SALEM), 2016. "Geotechnical Engineering Investigation: Proposed Renovations and Building Addition – Crenshaw Imperial Plaza, 2789 West Imperial Highway, Inglewood, California." 19 February 2016.
- Saucedo, G.J., Greene, H.G., Kennedy, M.P., and Bezore, S.P. Compilers, 2016. "Geologic Map of the Long Beach 30' x 60' Quadrangle, California," California Department of Conservation, Version 2.0.

Shaw, J.H., Plesch, A., Dolan, J.F., Pratt, T.L., and Fiore, P., 2002. "Puente Hills Blind-Thrust System, Los Angeles, California," *Bulletin of the Seismological Society of America*, Vol. 92, No. 8, pp. 2946-2960.

United States Geological Survey (USGS), 2008. "Appendix A: California Fault Parameters for the National Seismic Hazard Maps and Working Group on California Earthquake Probabilities," *Open File Report 2007-1437A*, Version 1.0.

Wright, T.L., 1991. "Structural Geology and Tectonic Evolution of the Los Angeles Basin, California," *American Association of Petroleum Geologists, Memoir 52*, p. 35-134.

Yerkes, R.F., McCulloh, T.H, Schoellhamer, J.E., and Vedder, J.G., 1965. "Geology of the Los Angeles Basin California – An Introduction," *USGS Professional Paper, 420-A*.

Figure 1: Project Site Location

Figure 2: Geologic Map

Figure 3: Regional Fault and Historical Earthquake Epicenter Map

Figures

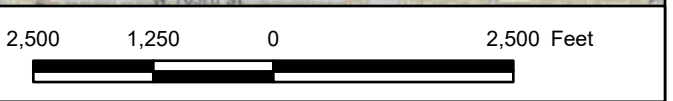
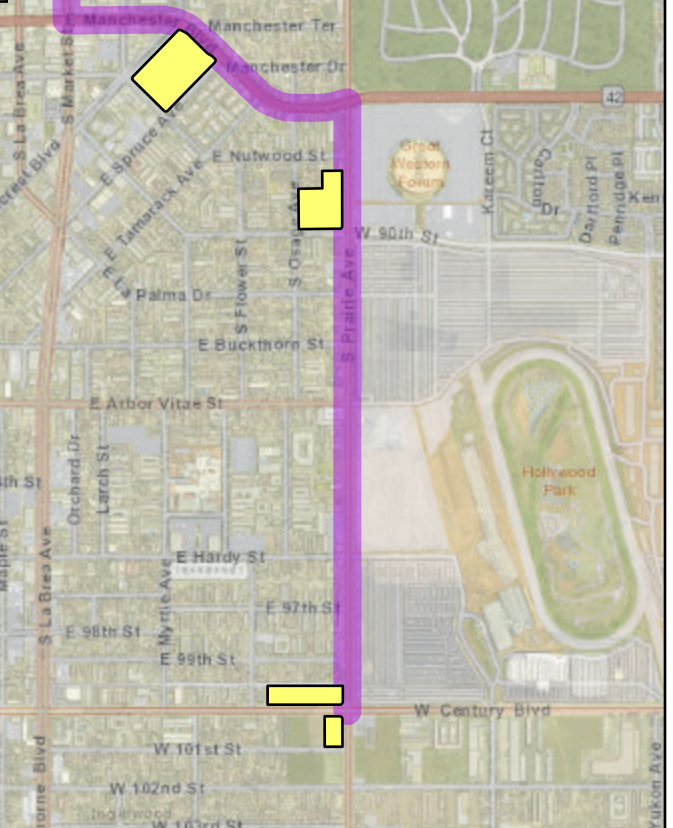
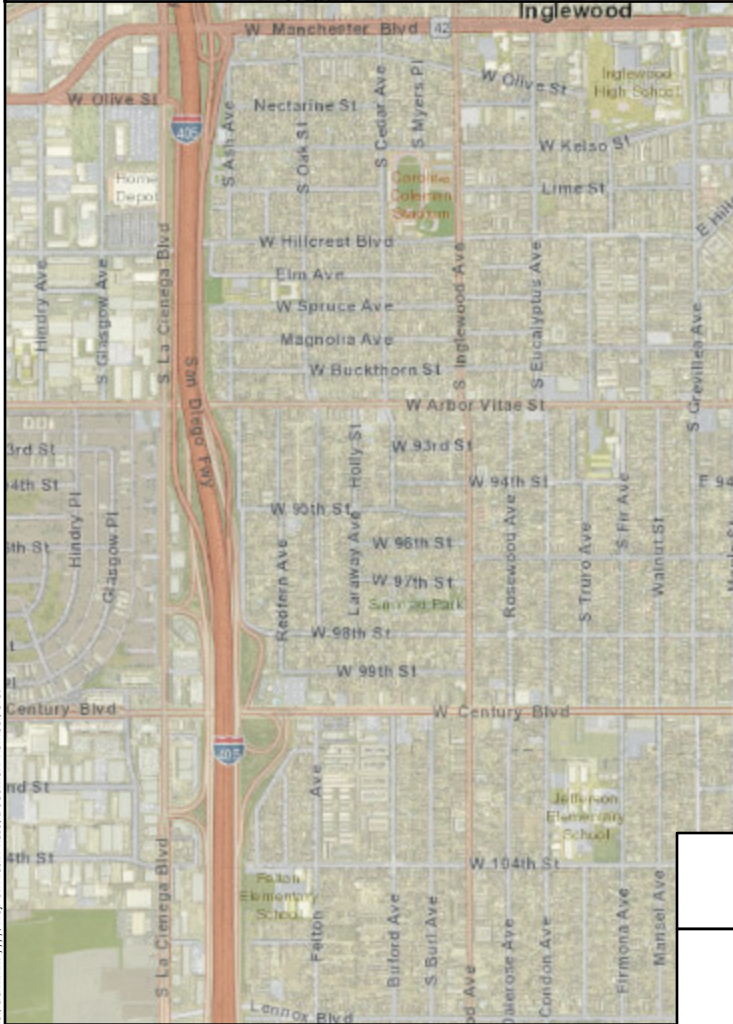
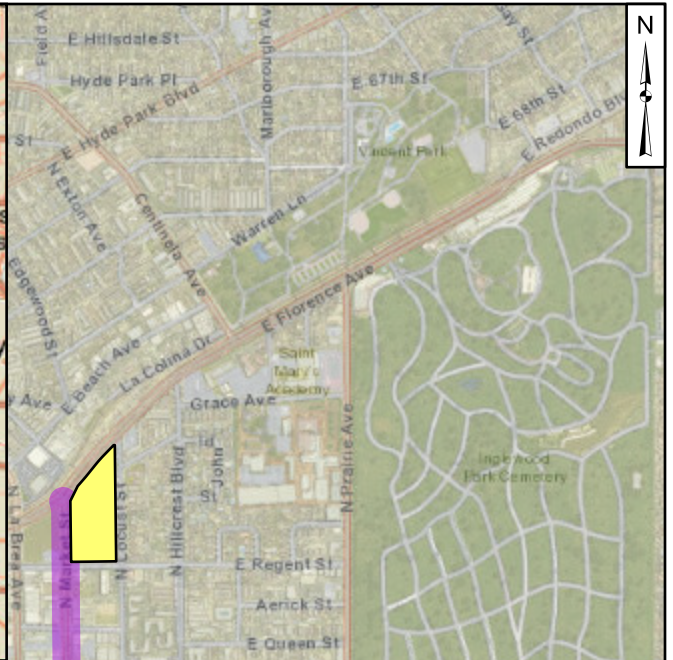
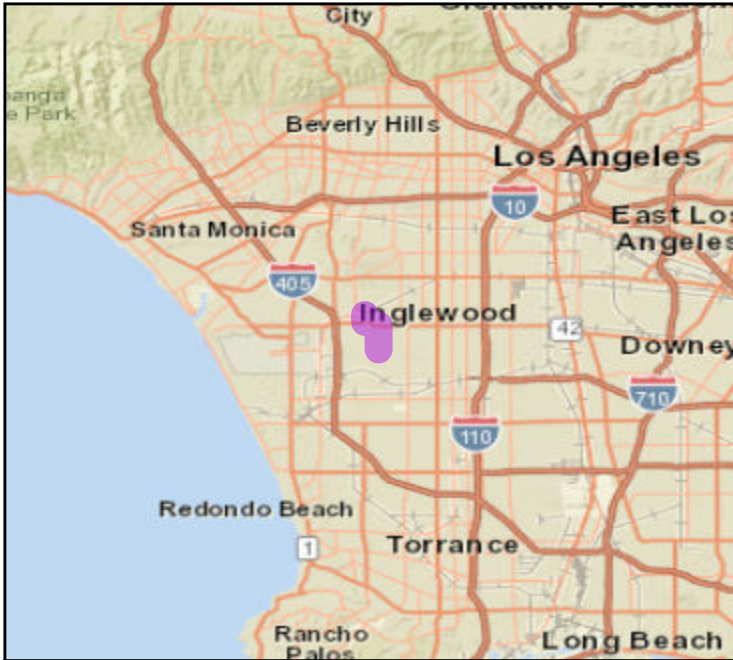



Project Site Location

Inglewood Transit Interconnector
Inglewood, California

Geosyntec
consultants

Figure

1

- Legend**
-  Inglewood Transit Connection Alignment
 -  Proposed Maintenance and Storage Facility Location

Notes:
The Inglewood Transit Connection consists of the curb-to-curb alignment along the route shown.

Pasadena, California

JUNE 2018

